

Астана +7(77172)727-132 Волгоград (844)278-03-48 Воронеж (473)204-51-73 Екатеринбург (343)384-55-89
Казань (843)206-01-48 Краснодар (861)203-40-90 Красноярск (391)204-63-61 Москва (495)268-04-70
Нижний Новгород (831)429-08-12 Новосибирск (383)227-86-73 Ростов-на-Дону (863)308-18-15
Самара (846)206-03-16 Санкт-Петербург (812)309-46-40 Саратов (845)249-38-78 Уфа (347)229-48-12
Единый адрес: alg@nt.ru Веб-сайт: aalborg.nt.ru

Technical Data Sheet No.: **TD0501M Rev. C**
Date of Issue: **August 2009**

OPERATING MANUAL

DFM

Digital Mass Flow Meter



Aalborg® is a registered trademark of Aalborg Instruments & Controls.

NOTE: Aalborg reserves the right to change designs and dimensions at its sole discretion at any time without notice. For certified dimensions please contact Aalborg®.

TABLE OF CONTENTS

1.	UNPACKING THE DFM MASS FLOW METER.....	1
1.1	Inspect Package for External Damage.....	1
1.2	Unpack the Mass Flow Meter.....	1
1.3	Returning Merchandise for Repair.....	1
2.	INSTALLATION.....	1
2.1	Primary Gas Connections.....	1
2.2	Electrical Connections.....	2
2.2.1	Power Supply Connections.....	2
2.2.2	Output Signals Connections.....	3
2.2.3	Output Communication Parameters and Connections.....	4
3.	PRINCIPLE OF OPERATION.....	6
4.	SPECIFICATIONS.....	7
4.1	CE Compliance.....	9
5.	OPERATING INSTRUCTIONS.....	12
5.1	Preparation and Warm Up.....	12
5.2	Swamping Condition.....	12
5.3	Programming DFM using LCD and Keypad.....	13
5.3.1	Changing Units of Measurement for Temperature & Pressure Reading...	13
5.3.2	Monitoring DFM peripheries settings.....	13
5.3.3	DFM Main Menu.....	14
5.3.4	Gas Flow Engineering Units Settings.....	15
5.3.5	Gas Table Settings.....	17
5.3.6	Totalizer Settings.....	18
5.3.7	Alarm Settings.....	20
5.3.8	Relay Assignment Settings.....	22
5.3.9	K Factors Settings.....	24
5.3.10	Zero Calibration.....	24
5.3.11	Flow Conditions Settings.....	26
5.3.12	LCD Backlit Energy-saving Setting.....	27
5.4	Flow, Temperature, Pressure Output Signals Configuration.....	27
6.	MAINTENANCE.....	28
6.1	Introduction.....	28
6.2	Flow Path Cleaning.....	29
6.2.1	Restrictor Flow Element (RFE).....	29
6.2.2	DFM 26/27 Models.....	29
6.2.3	DFM 36/37/46/47 models.....	30

7.	CALIBRATION PROCEDURES.....	30
7.1	Flow Calibration.....	30
7.2	Gas Flow Calibration of DFM Mass Flow Meters.....	31
7.2.1	Connections and Initial Warm Up.....	31
7.2.2	ZERO Check/Adjustment.....	31
7.2.3	Gas Linearization Table Adjustment.....	31
7.3	Analog output Calibration of DFM Mass Flow Meters.....	33
7.3.1	Initial Setup.....	34
7.3.2	Gas flow 0-5 Vdc analog output calibration.....	35
7.3.3	Gas flow 4-20 mA analog output calibration.....	35
7.3.4	Gas temperature 0-5 Vdc analog output calibration (DFM 27/37/47).....	35
7.3.5	Gas temperature 4-20 mA analog output calibration (DFM 27/37/47).....	36
7.3.6	Gas pressure 0-5 Vdc analog output calibration (DFM 27/37/47).....	36
7.3.7	Gas pressure 4-20 mA analog output calibration (DFM 27/37/47).....	37
7.4	Temperature or/and Pressure sensor Calibration.....	37
8.	RS-485/RS-232 SOFTWARE INTERFACE COMMANDS.....	37
8.1	General.....	37
8.2	Commands Structure.....	38
8.3	ASCII Commands Set.....	40
9.	TROUBLESHOOTING.....	46
9.1	Common Conditions.....	46
9.2	Troubleshooting Guide.....	47
9.3	Technical Assistance.....	49
10.	CALIBRATION CONVERSIONS FROM REFERENCE GASES.....	49
APPENDIX I	AALBORG DFM EEPROM Variables.....	50
APPENDIX II	INTERNAL USER SELECTABLE GAS FACTOR TABLE.....	53
	(INTERNAL "K" FACTORS)	
APPENDIX III	GAS FACTOR TABLE ("K" FACTORS).....	54
APPENDIX IV	COMPONENT DIAGRAM.....	58
APPENDIX V	DIMENSIONAL DRAWINGS.....	62
APPENDIX VI	WARRANTY.....	64

1. UNPACKING THE DFM MASS FLOW METER

1.1 Inspect Package for External Damage

Your DFM Mass Flow Meter was carefully packed in a sturdy cardboard carton, with anti-static cushioning materials to withstand shipping shock. Upon receipt, inspect the package for possible external damage. In case of external damage to the package contact the shipping company immediately.

1.2 Unpack the Mass Flow Meter

Open the carton carefully from the top and inspect for any sign of concealed shipping damage. In addition to contacting the shipping carrier please forward a copy of any damage report to your distributor or Aalborg® directly. When unpacking the instrument please make sure that you have all the items indicated on the Packing List. Please report any shortages promptly.

1.3 Returning Merchandise for Repair

Please contact the customer service representative of your distributor or Aalborg® if you purchased your Mass Flow Meter directly, and request a **Return Authorization Number (RAN)**. **Equipment returned without an RAN will not be accepted.** Aalborg® reserves the right to charge a fee to the customer for equipment returned under warranty claims if the instruments are tested to be free from warrantied defects. Shipping charges are borne by the customer. Meters returned "collect" will not be accepted! It is mandatory that any equipment returned for servicing be purged and neutralized of any dangerous contents including but not limited to toxic, bacterially infectious, corrosive or radioactive substances. No work shall be performed on a returned product unless the customer submits a fully executed, signed SAFETY CERTIFICATE. Please request form from the Service Manager.

2. INSTALLATION

2.1 Primary Gas Connections

Please note that the DFM Mass Flow Meter will not operate with liquids. Only clean gases are allowed to be introduced into the instrument. If gases are contaminated they must be filtered to prevent the introduction of impediments into the sensor.



Caution: It is the users responsibility to determine if the instrument is appropriate for their OXYGEN application, and for specifying O2 cleaning service if required. Aalborg is not liable for any damage or personal injury, whatsoever, resulting from the use of this instrument for oxygen.

Attitude limit of Mass Flow Meter is $\pm 15^\circ$ from calibration position (standard calibration is in horizontal position). This means that the gas flow path of the Flow Meter must be within this limit in order to maintain the original calibration accuracy. Should there be need for a different orientation of the meter, re-calibration may be necessary. It is also preferable to install the DFM transducer in a stable environment, free of frequent and sudden temperature changes, high moisture, and drafts.

Prior to connecting gas lines inspect all parts of the piping system including ferules and fittings for dust or other contaminants. Be sure to observe the direction of gas flow as indicated by the arrow on the front of the meter when connecting the gas system to be monitored. Insert tubing into the compression fittings until the ends of the properly sized tubing home flush against the shoulders of the fittings. Compression fittings are to be tightened according to the manufacturer's instructions to one and one quarter turns. Avoid over tightening which will seriously damage the Restrictor Flow Elements (RFE's)!



Caution: For models DFM 27/37/47 (Multi Parameter versions) the maximum pressure in the gas line should not exceed 100 PSIA (6.8 bars). Applying pressure above 100 PSIA (6.8 bars) for extended periods of time will seriously damage the pressure sensor. Burst pressure is 200 PSIA (13.6 bar)!

DFM transducers are supplied with standard 1/4 inch (DFM 26/27 and 36/37) or 3/8 inch (DFM 46/47), or optional 1/8 inch inlet and outlet compression fittings which should not be removed unless the meter is being cleaned or calibrated for a new flow range.

Using a Helium Leak Detector or other equivalent method perform a thorough leak test of the entire system. (All DFM's are checked prior to shipment for leakage within stated limits. See specifications in this manual.)

2.2 Electrical Connections

DFM is supplied with a 25 pin "D" connector. Pin diagram is presented in figure **b-1**.

2.2.1 Power Supply Connections

DFM transducers are supplied for three different power supply options:

$\pm 15\text{Vdc}$ (bipolar power supply)

DC Power (+)	-----	pin 1 of the 25 pin "D" connector
DC Power Common	-----	pin 18 of the 25 pin "D" connector
DC Power (-)	-----	pin 14 of the 25 pin "D" connector

+12Vdc or +24Vdc (unipolar power supply)

DC Power (+) ----- pin 1 of the 25 pin "D" connector

DC Power (-) ----- pin 18 of the 25 pin "D" connector



Caution: DO NOT CONNECT 24Vdc POWER SUPPLY UNLESS YOUR DFM METER WAS ORDERED AND CONFIGURED FOR 24Vdc!
(See power requirements label at the rear of the DFM meter)

2.2.2 Output Signals Connections



Caution: When connecting the load to the output terminals, do not exceed the rated values shown in the specifications. Failure to do so might cause damage to this device. Be sure to check that the wiring and the polarity of the power supply is correct before turning the power ON. Wiring error may cause damage or faulty operation.

DFM series Mass Flow Meters are equipped with either calibrated 0-5 VDC (0-10 VDC optional) or calibrated 4-20 mA output signals (jumper selectable). This linear output signal represents 0-100% of the flow meter's full scale range. Multi Parameter versions (DFM 27/37/47) are in addition equipped with either a calibrated 0-5 VDC (0-10VDC optional) or a calibrated 4-20 mA output signal (jumper selectable) for pressure and temperature. Pressure linear output signal represents 0-100PSIA (46.9 kPa). Temperature linear output signal represents 0-50 °C.



Warning: All 4-20 mA current loop outputs are self-powered (non-isolated).
Do not connect an external voltage source to the output signals!

Flow 0-5 VDC or 4-20 mA output signal connection:

Plus (+) ----- pin 2 of the 25 pin "D" connector

Minus (-) ----- pin 15 of the 25 pin "D" connector

Temperature 0-5 VDC or 4-20 mA output signal connection

(For DFM 27/37/47 only):

Plus (+) ----- pin 3 of the 25 pin "D" connector

Minus (-) ----- pin 16 of the 25 pin "D" connector

Pressure 0-5 VDC or 4-20 mA output signal connection

(For DFM 27/37/47 only):

Plus (+) ----- pin 4 of the 25 pin "D" connector

Minus (-) ----- pin 17 of the 25 pin "D" connector

To eliminate the possibility of noise interference, use a separate cable entry for the DC power and signal lines.

2.2.3 Communication Parameters and Connections

The digital interface operates via RS485 (optional RS-232 is available) and provides access to applicable internal data including: flow, temperature, pressure reading, auto zero, totalizer and alarm settings, gas table, conversion factors and engineering units selection, dynamic response compensation and linearization table adjustment.

Communication Settings:

Baud rate:	-----	9600 baud
Stop bit:	-----	1
Data bits:	-----	8
Parity:	-----	None
Flow Control:	-----	None

RS-485 communication interface connection:

The RS485 converter/adaptor has to be configured for: multidrop, 2 wire, half duplex mode. The transmitter circuit has to be enabled by TD or RTS (depending on which is available on the converter/adaptor). Settings for the receiver circuit usually should follow the selection made for the transmitter circuit in order to eliminate echo.

RS-485 T(-) or R(-)	-----	pin 11 of the 25 pin "D" connector (-)
RS-485 T(+) or R(+)	-----	pin 24 of the 25 pin "D" connector (+)
RS-485 GND (if available)	-----	pin 20 of the 25 pin "D" connector (GND)

RS-232 communication interface connection:

Crossover connection has to be established:

RS-232 RX (pin 2 on the DB9 connector)	-----	pin 11 of the 25 pin "D" connector (TX)
RS-232 TX (pin 3 on the DB9 connector)	-----	pin 24 of the 25 pin "D" connector (RX)
RS-232 GND (pin 5 on the DB9 connector)	-----	pin 20 of the 25 pin "D" connector (GND)

PIN FUNCTION

1	+15 Vdc (Optional +12 or +24 Vdc) Power Supply
2	0.5 Vdc or 4-20mA Flow Signal Output
3	0.5 Vdc or 4-20mA Temperature Signal Output (Optional)
4	0.5 Vdc or 4-20mA Pressure Signal Output (Optional)
5	(reserved)
6	(reserved)
7	(reserved)
8	Relay No. 1 - Common Contact
9	Relay No. 1 - Normally Open Contact
10	Relay No. 2 - Normally Closed Contact
11	RS485 (-) (Optional RS232 TX)
12	(No Connection)
13	Common
14	-15 VDC Power Supply (Only for ±15Vdc option)
15	Common, Signal Ground For Pin 2 (4-20 mA return)
16	Common, Signal Ground For Pin 3 (4-20 mA return)
17	Common, Signal Ground For Pin 4 (4-20 mA return)
18	Common, Power Supply (- DC power for 12 and 24 Vdc)
19	Common
20	RS232 Signal GND (RS-485 GND Optional)
21	Relay No. 1 - Normally Closed Contact
22	Relay No. 2 - Common Contact
23	Relay No. 2 - Normally Open Contact
24	RS485 (+) (Optional RS232 RX)
25	Chassis Ground

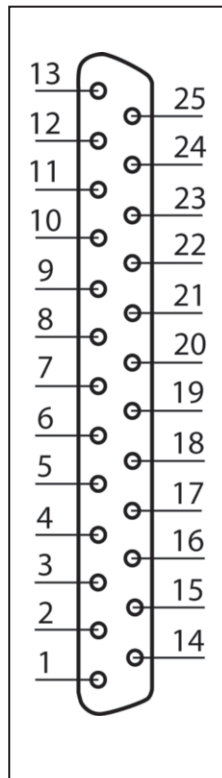

Figure b-1, DFM 25 Pin "D" Connector Configuration.



IMPORTANT NOTES: In general, "D" Connector numbering patterns are standardized. There are, however, some connectors with nonconforming patterns and the numbering sequence on your mating connector may or may not coincide with the numbering sequence shown in our pin configuration table above. It is imperative that you match the appropriate wires in accordance with the correct sequence regardless of the particular numbers displayed on the mating connector.



Make sure power is OFF when connecting or disconnecting any cables in the system.

The (+) and (-) power inputs are each protected by a 400mA M (medium time-lag) resettable fuse. If a shorting condition or polarity reversal occurs, the fuse will cut power to the flow transducer circuit. Disconnect the power to the unit, remove the faulty condition, and reconnect the power. The fuse will reset once the faulty condition has been removed. DC Power cable length may not exceed 9.5 feet (3 meters).

Use of the DFM flow transducer in a manner other than that specified in this manual or in writing from Aalborg®, may impair the protection provided by the equipment.

3. PRINCIPLE OF OPERATION

The stream of gas entering the Mass Flow transducer is split by shunting a small portion of the flow through a capillary stainless steel sensor tube. The remainder of the gas flows through the primary flow conduit. The geometry of the primary conduit and the sensor tube are designed to ensure laminar flow in each branch. According to principles of fluid dynamics the flow rates of a gas in the two laminar flow conduits are proportional to one another. Therefore, the flow rates measured in the sensor tube are directly proportional to the total flow through the transducer. In order to sense the flow in the sensor tube, heat flux is introduced at two sections of the sensor tube by means of precision wound heater sensor coils. Heat is transferred through the thin wall of the sensor tube to the gas flowing inside. As gas flow takes place heat is carried by the gas stream from the upstream coil to the downstream coil windings. The resultant temperature dependent resistance differential is detected by the electronic control circuit. The measured gradient at the sensor windings is linearly proportional to the instantaneous rate of flow taking place. An output signal is generated that is a function of the amount of heat carried by the gases to indicate mass molecular based flow rates. Additionally, the DFM model Mass Flow Meter incorporates a Digital Signal Processor (DSP) and non-volatile memory that stores all hardware specific variables and up to 10 different calibration tables. Multi parameter flow meters (Models: 27/37/47) provide accurate data on three different fluid parameters:

- flow
- pressure
- temperature

The flow rate can be displayed in volumetric flow or mass flow engineering units for standard or actual (temperature, pressure) conditions. Flow meters can be programmed locally via the four button keypad and LCD, or remotely, via the RS-232/RS-485 interface. DFM flow meters support various functions including: flow totalizer, flow, temperature, pressure alarms, automatic zero adjustment, 2 SPDT relays output, 0-5 Vdc / 0-10 Vdc / 4-20 mA analog outputs for flow, pressure and temperature.

4. SPECIFICATIONS

FLOW MEDIUM: Please note that DFM Mass Flow Meters are designed to work with clean gases only. Never try to measure flow rates of liquids with any DFM.

CALIBRATIONS: Performed at standard conditions [14.7 psia (101.4 kPa) and 70 °F (21.1 °C)] unless otherwise requested or stated.

ENVIRONMENTAL (PER IEC 664):
Installation Level II; Pollution Degree II.

FLOW ACCURACY FOR DFM 27/37/47 (INCLUDING LINEARITY):
0 °C to 50 °C and 5 to 100 psia (34.5 - 689.5 kPa): ±1% of full scale (F.S.)

FLOW ACCURACY FOR DFM 26/36/46 (INCLUDING LINEARITY):
±1% of FS at calibration temperature and pressure.

REPEATABILITY: ±0.15% of full scale.

FLOW TEMPERATURE COEFFICIENT:
0.15% of full scale/ °C or better.

FLOW PRESSURE COEFFICIENT:
0.01% of full scale/psi (6.895 kPa) or better.

FLOW RESPONSE TIME:
DFM 26/27: 300ms time constant; approximately 1 second to within ±2% of set flow rate for 25% to 100% of full scale flow.

DFM 36/46/37/47: 600ms time constant; approximately 2 seconds to within ±2% of set flow rate for 25% to 100% of full scale flow.

MAXIMUM BURST PRESSURE:
DFM 26/36/46: 1000 psig (6895 kPa gauge).
DFM 27/37/47: 200 psig (1379 kPa gauge).

PRESSURE MEASUREMENT RANGE:
0 to 100 psia (689.5 kPa absolute).
 $P(\text{absolute}) = P(\text{gauge}) + P(\text{atmospheric})$

PRESSURE MEASUREMENT ACCURACY:

±1% of F.S.

MAXIMUM PRESSURE DROP:

8 psi (at 100 L/min flow). See Table IV for pressure drops associated with various models and flow rates.

TEMPERATURE MEASUREMENT RANGE:

0 °C to 50 °C.

TEMPERATURE MEASUREMENT ACCURACY:

±1 °C.

GAS AND AMBIENT TEMPERATURE:

32 °F to 122 °F (0 °C to 50 °C).

14 °F to 122 °F (-10 °C to 50 °C) - Dry gases only.

RELATIVE GAS HUMIDITY:

Up to 70%.

LEAK INTEGRITY: 1×10^{-9} sccs He maximum to the outside environment.

ATTITUDE SENSITIVITY:

Incremental deviation of up to 1% from stated accuracy, after re-zeroing.

OUTPUT SIGNALS:

Linear 0-5 Vdc (3000 ohms min load impedance);

Linear 0-10Vdc (6000 ohms min impedance);

Linear 4-20 mA (500 ohms maximum loop resistance).

Maximum noise 20mV peak to peak (for 0-5 Vdc output).

TRANSDUCER INPUT POWER:

May be configured for three different options:

Bipolar ±15Vdc (±200 mA maximum);

Unipolar +12Vdc (300 mA maximum);

Unipolar +24Vdc (250 mA maximum);

Circuit boards have built-in polarity reversal protection.

Resettable fuses provide power input protection.

WETTED MATERIALS:

316 stainless steel, 416 stainless steel, VITON® O-rings;

BUNA-N®, NEOPRENE® or KALREZ® O-rings are optional.

Aalborg® makes no expressed or implied guarantees of corrosion resistance of mass flow meters as pertains to different flow media reacting with components of meters. It is the customers' sole responsibility to select the model suitable for a particular gas based on the fluid contacting (wetted) materials offered in the different models.

INLET AND OUTLET CONNECTIONS:

- Model DFM 26/27:** standard 1/4" compression fittings,
- Model DFM 36/37:** standard 1/4" compression fittings,
- Model DFM 46/47:** standard 3/8" compression fittings.

Optional 1/8" or 3/8" compression fittings and 1/4" VCR® fittings are available.

DISPLAY: 128 x 64 graphic LCD with backlight (up to 8 lines of text).
User selectable backlight saver.

CALIBRATION OPTIONS:

Standard is one 10 points NIST calibration. Optional, up to 9 additional calibrations may be ordered at additional charge.

CE COMPLIANCE:

EMC Compliance with 89/336/EEC as amended.
Emission Standard: EN 55011:1991, Group 1, Class A
Immunity Standard: EN 55082-1:1992

Table I DFM 26/27 Low Flow Mass Flow Meters*

CODE	scc/min [N ₂]	CODE	std liters/min [N ₂]
01	0 to 10	07	0 to 1
02	0 to 20	08	0 to 2
03	0 to 50	09	0 to 5
04	0 to 100	10	0 to 10
05	0 to 200		
06	0 to 500		

Table II DFM 36/37 Medium Flow Mass Flow Meters *

CODE	standard liters/min [N ₂]
11	0 to 15
30	20
31	30
32	40
33	50

Table III DFM 46 High Flow Mass Flow Meters *80

CODE	standard liters/min [N ₂]
40	60
41	80
42	100

* Flow rates are stated for Nitrogen at STP conditions [i.e. 70 °F (21.1 °C) at 1 atm]. For other gases use the K factor as a multiplier from APPENDIX 2.

Table IV Pressure Drops

MODEL	FLOW RATE [std liters/min]	MAXIMUM PRESSURE DROP		
		[mm H ₂ O]	[psid]	[kPa]
DFM 26/27	up to 10	25	0.04	0.276
DFM 36/37	20	300	0.44	3.03
	30	800	1.18	8.14
	40	1480	2.18	15.03
	50	2200	3.23	22.3
DFM 46/47	60	3100	4.56	31.4
	100	5500	8.08	55.7

Table V Approximate Weights

MODEL	WEIGHT	SHIPPING WEIGHT
DFM 26/27 transmitter	2.20 lbs (1.00 kg)	3.70 lbs (1.68 kg)
DFM 36/46/37/47 transmitter	2.95 lbs (1.33 kg)	4.34 lbs (1.97 kg)

5. OPERATING INSTRUCTIONS

5.1 Preparation and Warm Up

It is assumed that the Digital Mass Flow Meter has been correctly installed and thoroughly leak tested as described in section 2. Make sure the flow source is OFF. When applying power to a flow meter within the first two seconds you will see on the LCD display: the product name, the software version, and revision of the EEPROM table. After two seconds the LSD display switches to the main screen with the following information:

- Temperature and Pressure reading (for models DFM 27/37/47 only).
- Mass Flow reading in current engineering units.
- Current Gas Table and Gas Name.
- Totalizer Volume reading in current volume based engineering units.
- Totalizer , Alarm, and Relays status.

72.5 °F	14.7 PSI
2.4	%F.S.
G: 1 NITROGEN	N2
TOT:	25418 %s
TOT: R	A: SN R1:N R2:N

DFM Main Screen



Note: Allow the Digital Mass Flow Meter to warm-up for a minimum of 15 minutes.

During initial powering of the DFM transducer, the flow output signal will be indicating a higher than usual output. This is an indication that the DFM transducer has not yet attained it's minimum operating temperature. This condition will automatically cancel within a few minutes and the transducer should eventually zero.

5.2 Swamping Condition

If a flow of more than 10% above the maximum flow rate of the Mass Flow Meter is taking place, a condition known as "swamping" may occur. Readings of a "swamped" meter cannot be assumed to be either accurate or linear. Flow must be restored to below 110% of maximum meter range. Once flow rates are lowered to within calibrated range, the swamping condition will end. Operation of the meter above 110% of maximum calibrated flow may increase recovery time.

5.3 Programming DFM using LCD and Keypad

All features of the flow meter can be accessed via the local four button keypad and LCD. The LCD incorporates an energy-saving auto shut-off backlit feature. If enabled, after 15 minutes of operation without user intervention the LCD backlit turns off. In order to turn on the LCD backlit press any key on the keypad. The LCD backlit energy-saving auto shut-off feature can be disabled or enabled by user (see p. 5.3.12 "LCD backlit Energy-saving Setting").

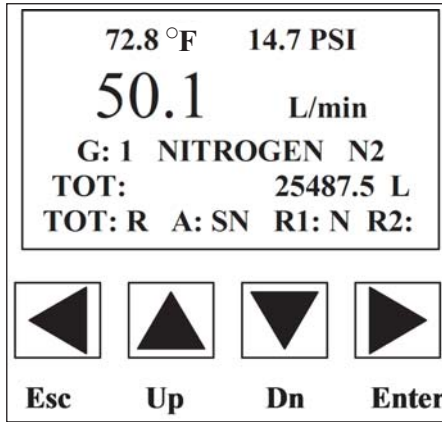

5.3.1 Changing Units of measurement for Temperature and Pressure reading

By default after power up the temperature reading is displayed in °F and pressure in PSI. Pressing (▶) [Enter] button from main screen will alter the units of measure to °C for temperature and kPa for pressure reading respectively. In order to change units of measure back to °F for temperature and PSI for pressure press (▶) [Enter] button while in the main screen one more time.

5.3.2 Monitoring DFM Peripherals Settings

The last row at the bottom of the main LCD screen reflects settings and status for Totalizer, Flow Alarm, and Relays (see Figure b-2).

Totalizer Status:

- TOT: R - totalizer is running (Enabled).
- TOT: S - totalizer is stopped (Disabled).

Flow Alarm Status:

- A: S - flow alarm is disabled.
- A: R,N - flow alarm is enabled and currently there are no alarm conditions.
- A: R,L - flow alarm is enabled and currently there is Low alarm condition.
- A: R,H - flow alarm is enabled and currently there is High alarm condition.

Relay Settings:

- N** - No assignment (relay is not assigned to any events).
- H** - High Flow Alarm condition.
- L** - Low Flow Alarm condition.
- R** - Range between High and Low Flow Alarm condition.
- T** - Totalizer reached set limit.
- A** - High Temperature Alarm condition.
- B** - Low Temperature Alarm condition.
- C** - High Pressure Alarm condition.
- D** - Low Pressure Alarm condition.

Continued pressing of the (▲) [Up] button from the main screen will switch the status line to display the following information:

- Calibrated Full scale range in standard L/min for current Gas Table.
- Device Digital Communication interface type (RS-485 or RS-232).
- Device RS-485 address (two hexadecimal characters).
- Device Zero DAC counts (for troubleshooting purposes).
- Device Sensor Average ADC counts (for troubleshooting purposes).
- Device Sensor Compensated ADC counts (for troubleshooting purposes).



Note: Pressing the (▼) [Dn] button from any of the status line will switch the status display to one step back.

5.3.3 DFM Main Menu

Pressing of the (◀) [Esc] button from the main screen will switch the display to the Main Menu. The following screen will appear:

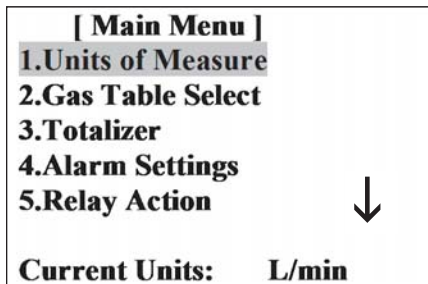

Figure b-3, DFM Main Menu Screen

Pressing of the (▲) [Up] or (▼) [Dn] buttons allows the user to scroll up or down the menu options. Press (▶) [Enter] button to select the highlighted option of the menu.

The following menu options are available:

1. **Units of Measure -**
View or Change the Units of Measure for Flow process variable.
2. **Gas Table Select -**
View or Change the Gas Table.
3. **Totalizer -**
View or Change settings for Totalizer.
4. **Alarm Settings -**
View or Change settings for Flow , Pressure and Temperature Alarm.
5. **Relay Action -**
View or Change settings for each of two available Relays.
6. **K Factors -**
View or Change settings for User defined or Internal K Factors.
7. **Zero Calibration -**
Initiate Automatic Sensor Zero Calibration.
8. **Flow Conditions -**
Allows the user to set the Actual or Standard Flow conditions.
9. **BackLight Timer -**
Allows the user to turn On/Off the Energy-saving for LCD backlit.
10. **Exit -**
Returns to the Main Screen with process variables reading.



Note: Pressing the [Esc] button from any level of the Menu will switch the menu to one level higher (up to Main Screen).

5.3.4 Gas Flow Engineering Units Settings

While in the Main Menu scroll with (▲) [Up] or (▼) [Dn] buttons to highlight the Units of Measure option and press the (▶) [Enter] button. The following screen will appear:

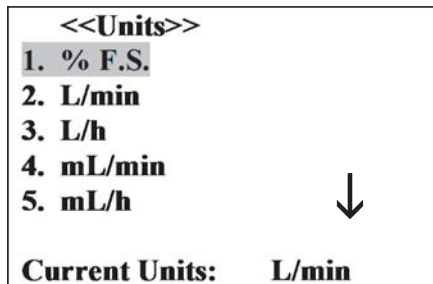

Figure b-4, DFM Units of Measure Screen

The following Engineering Units menu options are available:

1. % F.S. - percent of full scale.
2. L/min - Liters per minute.
3. L/h - Liters per hour.
4. mL/min- milliliters per minute.
5. mL/h - milliliters per hour.
6. SCFH - cubic feet per hour.
7. SCFM - cubic feet per minute.
8. LbPH - pounds per hour.
9. LbPM - pounds per minute.
10. User - User defined Unit of Measure.
11. Exit - Exit to Main Menu

Selecting option 1 to 9 sets the corresponding Unit of Measure and switches the LCD back to Main Menu.



Note: Once Flow Unit of Measure is changed the Totalizer's Volume based Unit of Measure will be changed automatically.

If the User defined Unit of Measure option is selected the following screen will appear:

User Defined Unit:

K factor : 1.0000

Enter Volume K factor

Figure b-5, User Defined Unit of Measure Screen (K factor)

In order to specify the User Defined Unit of Measure user has to set three key parameters:

- K factor:** - Conversion factor relative to L/min unit of measure.
- Time base:** - Hours, Minutes, or Seconds
- Density:** - Use density (YES / NO)

Press the (▶) **[Enter]** button, to move the flashing cursor to the digit, which has to be adjusted. Pressing (▲) or (▼) will increment or decrement a particular digit respectively. The numbers will change from 0 to 9 and next to the decimal

point (.). Pressing the (▲) button one more time will change the digit on the highlighted position of the cursor back to 0. The same is true in reverse, when pressing the (▼) button. Only one decimal point is allowed. If changing position of the decimal point is required, change decimal point to any desired digit then move the cursor to the required position and adjust it to the decimal point with (▲) or (▼) button. When complete with K-factor value settings, press the (◀) [Esc] button to move in to the Time base settings screen. The following screen will appear:

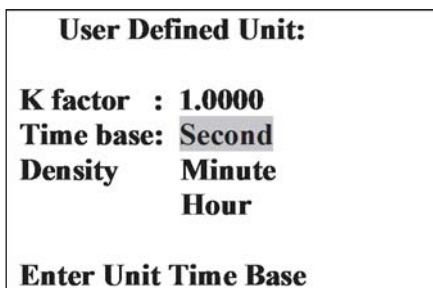

Figure b-6, User Defined Unit of Measure Screen (Time base)

Use (▲) or (▼) buttons to highlight desired time base option. Press the (▶) [Enter] button to set the Time base and move in to the Density settings screen. The following screen will appear:

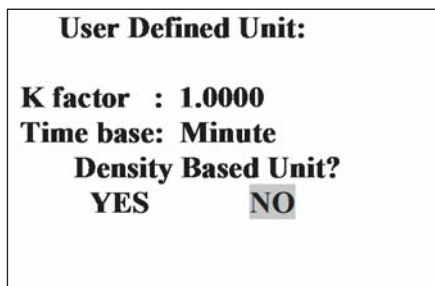

Figure b-7, User Defined Unit of Measure Screen (Density)

Use (▲) or (▼) buttons to highlight desired Density option. Press the (▶) [Enter] button when done. The LCD will display the Units of Measure Screen and new settings will be reflected at the bottom status line.

5.3.5 Gas Table Settings

The DFM Mass Flow Meter is capable to store calibration data for up to 10 different gases.



Note: By default the DFM is shipped with at least one valid calibration table (unless optional additional calibrations were ordered). If instead of the valid Gas Name (for example NITROGEN) the main screen displays Gas designator as "Uncalibrated", then user have chosen the gas table which was not calibrated. Using an Uncalibrated Gas Table will result in erroneous reading.

From the Main Menu, the user would traverse the menu tree until reaching the "Gas Table Select" menu. The following screen will appear:

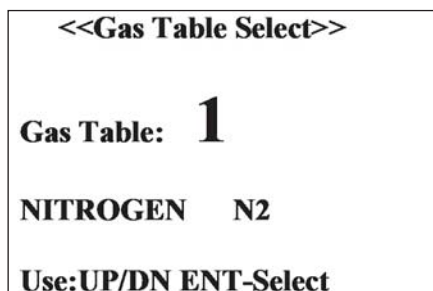

Figure b-8, Current Gas Table Settings

Use (▲) or (▼) buttons to select desired Gas Table, press the (▶) [Enter] button when done. The LCD will display the Main Menu screen. If desired, press the (◀) [Esc] button to go back to the Main DFM screen. The new gas table number and the name of the gas will be reflected on the Main DFM screen.

5.3.6 Totalizer Settings

The total volume of the gas is calculated by integrating the actual gas flow rate with respect to time. Both keypad menu and digital interface commands are provided to:

- set the totalizer to ZERO
- start the totalizer at a preset flow
- assign action at a preset total volume
- start/stop (enable/disable) totalizing the flow
- read totalizer

The Totalizer has several attributes which may be configured by the user. These attributes control the conditions which cause the Totalizer to start integrating of the gas flow and also specifying actions to be taken when the Total Volume is outside the specified limit.



Note: Before enabling the Totalizer, ensure that all totalizer settings are configured properly. Totalizer Start values have to be entered in %F.S. engineering unit. Totalizer will not totalize until the flow rate becomes equal or more than the Totalizer Start value. Totalizer Stop values have to be entered in volume / mass based engineering units.

Totalizer action conditions become true, when the totalizer reading and preset "Stop at Total" volumes are equal.

From the Main Menu, the user would traverse the menu tree until reaching the "Totalizer" menu. The following screen will appear:

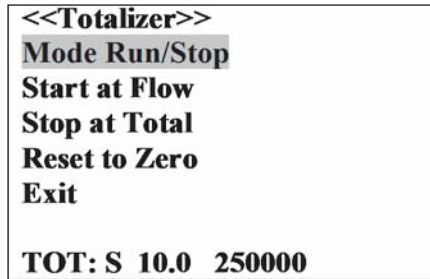

Figure b-9, Totalizer Settings

- Mode Run/Stop** - Allows the user to Enable/Disable Totalizer
- Start at Flow** - Allows the user to enter Gas flow rate in %F.S. at which Totalizer starts integrating of the gas flow.
- Stop at Total** - Allows the user to enter Totalizer Limit Volume when user defined action will occur.
- Reset to Zero** - Allows the user to reset Totalizer reading to zero.

Use (▲) or (▼) buttons to highlight "Mode Run/Stop" option and press the (▶) [Enter] button. The following screen will appear:

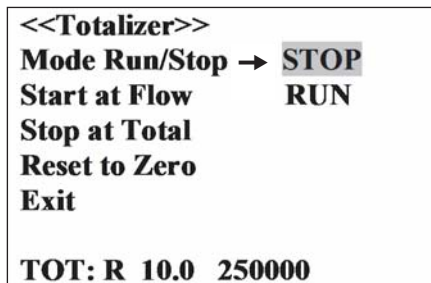

Figure b-10, Totalizer Settings (Stop/Run)

Use (▲) or (▼) buttons to highlight "Start at Flow" option and press the (▶) [Enter] button. The following screen will appear:

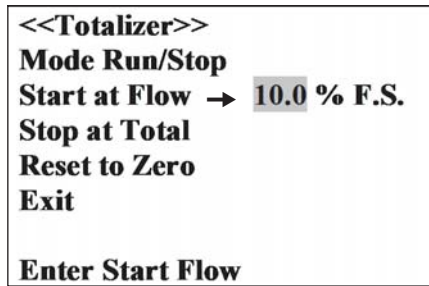

Figure b-11, Totalizer Settings (Start)

Pressing (▲) or (▼) will increment or decrement Start Flow value per 0.1% F.S. respectively. When done with adjustment, press the (▶) [Enter] button.

Use (▲) or (▼) buttons to highlight "Stop at Total" option and press the (▶) [Enter] button. The following screen will appear:

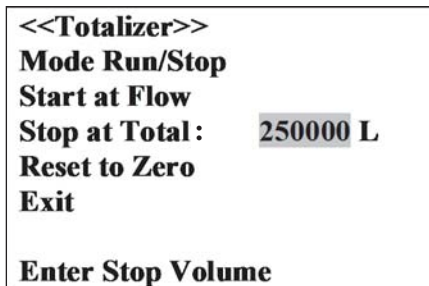

Figure b-12, Totalizer Settings (Stop)

Press the (▶) [Enter] button, to move the flashing cursor to the digit, which has to be adjusted. Pressing (▲) or (▼) will increment or decrement a particular digit respectively. The numbers will change from 0 to 9 and next to the decimal point (.). Pressing the (▲) button one more time will change the digit on the highlighted position of the cursor back to 0. The same is true in reverse, when pressing the (▼) button. Only one decimal point is allowed. If changing position of the decimal point is required, change decimal point to any desired digit then move the cursor to the required position and adjust it to the decimal point with (▲) or (▼) button. When done with adjustment, press the (◀) [Esc] button.

5.3.7 Alarm Settings

DFM provides the user a flexible alarm/warning system that monitors the Process Variables (Gas Flow, Pressure and Temperature) for conditions that fall outside

configurable limits and then provides feedback to the user visually via the LCD (only for Flow) or via a Relay contact closure.

There are three different Alarms:

- Gas Flow
- Gas Temperature
- Gas Pressure

Each alarm has several attributes which may be configured by the user. These attributes control the conditions which cause the alarm to occur and also specify actions to be taken when the Process Variable is outside the specified conditions.



Note: All three alarms are non-latching. That means the alarm is indicated only while the monitored value exceeds the specified conditions.

From the Main Menu, the user would traverse the menu tree until reaching the "Alarm Settings" menu. The following screen will appear:

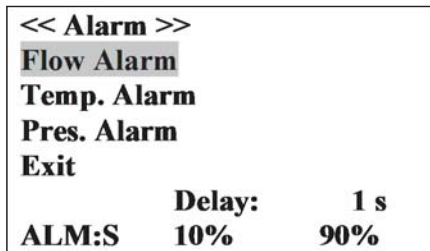

Figure b-13, Alarm Settings

Use (▲) or (▼) buttons to highlight "Flow Alarm" option and press the (▶) [Enter] button. The following screen will appear:

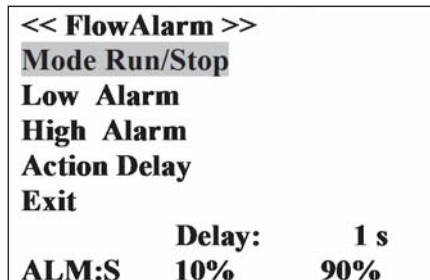

Figure b-14, Flow Alarm Settings

Mode Run/Stop - Allows the user to Enable/Disable Flow Alarm

Low Alarm - The value of the monitored Flow in % F.S. below which is considered an alarm condition.



Note: The value of the Low alarm has to be less than the value of the High Alarm.

High Alarm - The value of the monitored Flow in % F.S. above which is considered an alarm condition.



Note: The value of the High alarm has to be more than the value of the Low Alarm.

Action Delay - The time in seconds that the Flow rate value must remain above the high limit or below the low limit before an alarm condition is indicated. Valid settings are in the range from 0 to 3600 seconds.



Note: If the alarm condition is detected, and the Relay is assigned to Alarm event, then the corresponding Relay will be energized.

The user can enable and configure Temperature and Pressure Alarms via the similar menu:

Main Menu " Alarm Settings " Temp. Alarms - For Temperature Alarm

Main Menu " Alarm Settings " Pres. Alarms - For Pressure Alarm



Note: High and Low limits for the Temperature Alarm have to be entered in °C. High and Low limits for the Pressure Alarm have to be entered in the currently set engineering units: PSI or kPa (absolute).

$P (\text{absolute}) = P (\text{gauge}) + P (\text{atmospheric}).$

5.3.8 Relay Assignment Settings

Two sets of dry contact relay outputs are provided to actuate user supplied equipment. These are programmable via local keypad or digital interface such that the relays can be made to switch when a specified event occurs (e.g. when a low or high flow, pressure or temperature alarm limit is exceeded or when the totalizer reaches a specified value).

From the Main Menu, the user would traverse the menu tree until reaching the "Relay Action" menu. The following screen will appear:

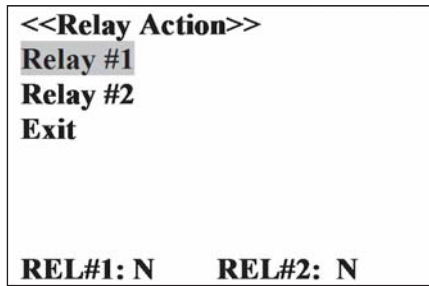

Figure b-15, Relay Assignment Screen

The user selects a Relay by scrolling up/down the list of available Relays until the desired Relay is highlighted and then presses the (▶) [Enter] button. The following screen will appear:

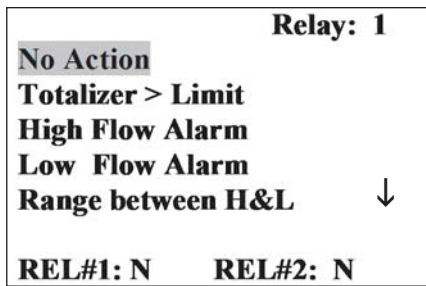

Figure b-16, Relay #1 Action Settings

The user can configure the Relay action from 9 different options:

- No Action** : (N) No assignment (relay is not assigned to any events).
- Totalizer > Limit** : (T) Totalizer reached set limit volume.
- High Flow Alarm** : (H) High Flow Alarm condition.
- Low Flow Alarm** : (L) Low Flow Alarm condition.
- Range between H&L** : (R) Range between High and Low Flow Alarm condition.
- High Temp. Alarm** : (A) High Temperature Alarm condition.
- Low Temp. Alarm** : (B) Low Temperature Alarm condition.
- High Pres. Alarm** : (C) High Pressure Alarm condition.
- Low Pres. Alarm** : (D) Low Pressure Alarm condition.
- Exit**

The user selects an Action by scrolling up/down the list of available options until the desired option is highlighted and then presses the (▶) [Enter] button.

5.3.9 K Factors Settings

Conversion factors relative to Nitrogen for up to 32 gases are stored in the DFM (see APPENDIX II). In addition, provision is made for a user defined conversion factor. Conversion factors may be applied to any of the ten gas calibrations via keypad or digital interface commands.

The available K Factor settings are:

- **Disabled** (K = 1)
- **Internal Index** The index [0-31] from internal K factor table (see APPENDIX II).
- **User Defined** User defined conversion factor



Note: The conversion factors will not be applied for % F.S. engineering unit.

From the Main Menu, the user would traverse the menu tree until reaching the "K Factors" menu. The following screen will appear:

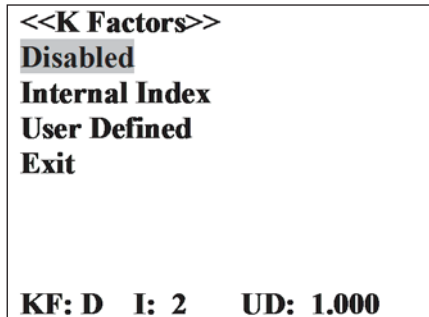

Figure b-17, K Factors Screen

The user selects a K factor by scrolling up/down the list of available options until the desired option is highlighted and then presses (▶) [Enter] button. For Internal Index and User Defined options user will be prompted to enter desired index/value of conversion factor.

5.3.10 Zero Calibration

The DFM includes an auto zero function that when activated, automatically adjusts the mass flow sensor to read zero. The initial zero adjustment for your DFM was performed at the factory. It is not required to perform zero calibration unless the device has zero reading offset with no flow conditions.



Note: Before performing Zero Calibration make sure the device is powered up for at least 30 minutes and absolute no flow condition is established.

Shut off the flow of gas into the Digital Mass Flow Meter. To ensure that no seepage or leak occurs into the meter, it is good practice to temporarily disconnect the gas source. From the Main Menu, the user would traverse the menu tree until reaching the "Zero Calibration" menu. The following screen will appear:

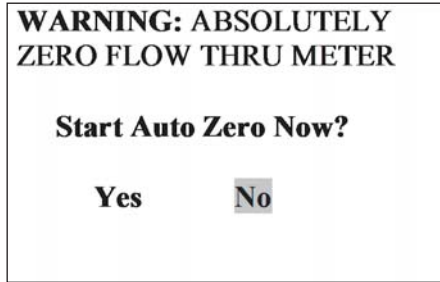

Figure b-18, Zero Calibration (Start)

The user must acknowledge the warning that the Auto Zero procedure is about to be started and there is absolutely zero flow thru the meter. Selecting YES confirms that user has taken the necessary precautions and starts Auto Zero algorithm. Selecting NO aborts the Auto Zero procedure.

To start Auto Zero use (▲) or (▼) buttons to highlight "Yes" option and press the (►) [Enter] button. The following screen will appear:

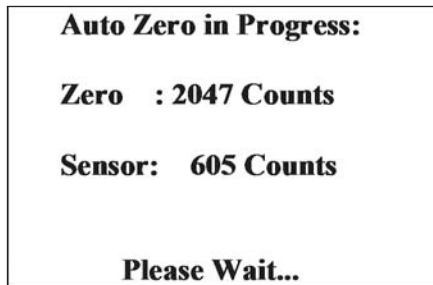

Figure b-19, Zero Calibration (In progress)

The Auto Zero procedure normally takes 2 - 3 minutes during which Zero and Sensor reading will be changed approximately every 4 seconds. The nominal value for fully balanced sensor is 120 Counts. If the DFM's digital signal processor was able to adjust the Sensor reading within 120 ± 2 counts, then Auto Zero is considered as successful and the screen below will appear:

<p>Auto Zero is Done!</p> <p>Zero : 1875 Counts</p> <p>Sensor: 121 Counts</p> <p>Press Any Key...</p>

Figure b-20, Zero Calibration (Completed)

If the device was unable to adjust Sensor reading to within 120 ± 2 counts, then Auto Zero is considered as unsuccessful and user will be prompted with "Auto Zero is Failed!" screen.

5.3.11 Flow Conditions Settings

For DFM 27/37/47 models the flow reading can be displayed for standard or actual conditions (Temperature / Pressure adjusted). Since mass flow sensors are sensitive to changes in gas density and gas velocity, all mass flow meters indicate flow rates with reference to a set of standard conditions. For Aalborg® Instruments, standard conditions are defined as 21.1° C (70° F) and 101.3 kPa (14.7 psia). Other manufacturers may use different values. Standard flow rate is the flow rate the gas would be moving if the temperature and pressure were at standard conditions. It is usually the most convenient measure of the gas flow because it defines the heat-carrying capacity of the air. Actual (volumetric) flow rate is the true volume flow of the gas exiting the flow meter. In some instances, actual (volumetric) flow rate rather than standard flow rate may be of interest. To display actual (volumetric) flow rate, the DFM will multiply the standard flow measurement by the following density correction factor:

$$ActualFlow = StdFlow \cdot \frac{Ta + 273.16}{294.26} \cdot \frac{14.7}{Pa(psi)}$$

Where:

Ta = Actual gas temperature measured by the DFM in units of degrees Celsius

Pa = Actual absolute pressure measured by the DFM in units of PSI



Note: The Actual Flow reading will not be calculated for % F.S. engineering unit.

In order to select Standard or Actual flow measurement user would traverse the menu tree until reaching the "Flow Conditions" menu. The following screen will appear:

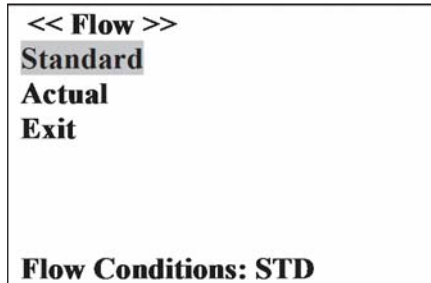

Figure b-21, Flow Condition Screen

Use (▲) or (▼) buttons to highlight desired option and press the (▶) [Enter] button.

5.3.12 LCD backlit Energy-Saving Setting

The DFM's LCD incorporates Energy-saving auto shut-off backlit feature. If enabled, after 15 minutes of operation without user intervention the LCD backlit turns off. In order to turn on LCD backlit press any key on the keypad. In order to enable/disable Energy-saving auto shut-off backlit feature user would traverse the menu tree until reaching the "Back Light Timer" menu. The following screen will appear:

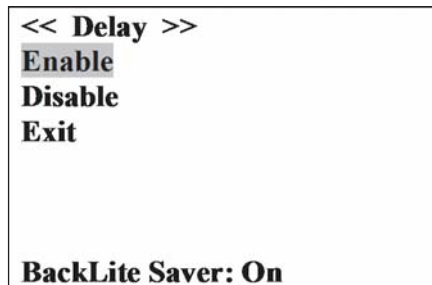

Figure b-22, LCD backlit Energy-saving Screen

Use (▲) or (▼) buttons to highlight desired option and press the (▶) [Enter] button.

5.4 Flow, Temperature, Pressure output Signals Configuration

DFM series Mass Flow Meters are equipped with calibrated 0-5 Vdc (0-10 Vdc optional) and 4-20 mA output signals. The set of the jumpers (J2, J3, J4) on the analog printed circuit board is used to switch between 0-5 Vdc, 0-10 Vdc or 4-20 mA output signals (see Table VI).



Note: DFM 26/36/46 models are equipped with gas flow rate output signal only. DFM 27/37/47 models in addition provide output signals for temperature and pressure.

Analog output signals of 0-5 Vdc, (0-10 Vdc optional) or 4-20 mA are attained at the appropriate pins of the 25-pin "D" connector (see Figure **b-1**) on the side of the DFM transducer.

Table VI Analog Output Jumper Configuration

ANALOG SIGNAL	0-5 VDC		0-10 VDC		4-20 mA	
	J2.A	5-9	J2.A	5-9	J2.A	1-5
Flow Rate Output	J2.B	2-6	J2.B	2-6	J2.B	2-6
	J2.C	7-11	J2.C	7-11	J2.C	3-7
Jumper Header J2	J2.D	8-12	J2.D	8-12	J2.D	4-8
	J3.A	5-9	J3.A	5-9	J3.A	1-5
Temperature Output	J3.B	2-6	J3.B	2-6	J3.B	2-6
	J3.C	7-11	J3.C	7-11	J3.C	3-7
Jumper Header J3	J3.D	8-12	J3.D	8-12	J3.D	4-8
	J4.A	5-9	J4.A	5-9	J4.A	1-5
Pressure Output	J4.B	2-6	J4.B	2-6	J4.B	2-6
	J4.C	7-11	J4.C	7-11	J4.C	3-7
Jumper Header J4	J4.D	8-12	J4.D	8-12	J4.D	4-8

See APPENDIX IV for actual jumpers layout on the analog PCB.

6. MAINTENANCE

6.1 Introduction

It is important that the Mass Flow Meter is used with clean, filtered gases only. Liquids may not be metered. Since the RTD sensor consists, in part, of a small capillary stainless steel tube, it is prone to occlusion due to impediments or gas crystallization. Other flow passages are also easily obstructed. Therefore, great care must be exercised to avoid the introduction of any potential flow impediment. To protect the instrument a 50 micron (DFM26/27) or 60 micron (DFM 36/46/37/47) filter is built into the inlet of the flow transducer. The filter screen and the flow paths may require occasional cleaning as described below. There is no other recommended maintenance required. It is good practice, however, to keep the meter away from vibration, hot or corrosive environments and excessive RF or magnetic interference. If periodic calibrations are required they should be performed by qualified personnel and calibrating instruments, as described in section 7. It is recommended that units are returned to Aalborg® for repair service and calibration.



CAUTION: TO PROTECT SERVICING PERSONNEL IT IS MANDATORY THAT ANY INSTRUMENT BEING SERVICED IS COMPLETELY PURGED AND NEUTRALIZED OF TOXIC, BACTERIOLOGICALLY INFECTED, CORROSIVE OR RADIOACTIVE CONTENTS.

6.2 Flow Path Cleaning

Before attempting any disassembly of the unit for cleaning, try inspecting the flow paths by looking into the inlet and outlet ends of the meter for any debris that may be clogging the flow through the meter. Remove debris as necessary. If the flow path is clogged, proceed with steps below.

Do not attempt to disassemble the sensor. If blockage of the sensor tube is not alleviated by flushing through with cleaning fluids, please return meter for servicing.



NOTE: DISASSEMBLY MAY COMPROMISE CURRENT CALIBRATION.

6.2.1 Restrictor Flow Element (RFE)

The Restrictor Flow Element (RFE) is a precision flow divider inside the transducer, which splits the inlet gas flow by a preset amount to the sensor and main flow paths. The particular RFE used in a given Mass Flow Meter depends on the gas and flow range of the instrument.

6.2.2 DFM 26/27 models

Unscrew the inlet compression fitting of meter. Note that the Restrictor Flow Element (RFE) is connected to the inlet fitting. Carefully disassemble the RFE from the inlet connection. The 50 micron filter screen will now become visible. Push the screen out through the inlet fitting. Clean or replace each of the removed parts as necessary. If alcohol is used for cleaning, allow time for drying. Inspect the flow path inside the transducer for any visible signs of contaminant. If necessary, flush the flow path through with alcohol. Thoroughly dry the flow paths by flowing clean dry gas through. Carefully re-install the RFE and inlet fitting, avoiding any twisting and deforming the RFE. Be sure that no dust has collected on the O-ring seal.



NOTE: OVER TIGHTENING WILL DEFORM AND RENDER THE RFE DEFECTIVE. IT IS ADVISABLE THAT AT LEAST ONE CALIBRATION POINT BE CHECKED AFTER RE-INSTALLING THE INLET FITTING-SEE SECTION (7.2.3).

6.2.3 DFM 36/46/37/47 Models

Unscrew the four socket head cap screws (two 10-24 and two 6-32) at the inlet side of the meter. This will release the short square block containing the inlet compression fitting. The 60 micron filter screen will now become visible. Remove the screen. DO NOT remove the RFE inside the flow transducer! Clean or replace each of the removed parts as necessary. If alcohol is used for cleaning, allow time for drying. Inspect the flow path inside the transducer for any visible signs of contaminants. If necessary, flush the flow path through with alcohol. Thoroughly dry the flow paths by flowing clean dry gas through. Re-install the inlet parts and filter screen. Be sure that no dust has collected on the O-ring seal. It is advisable that at least one calibration point be checked after re-installing the inlet fitting - see section 7.

7. CALIBRATION PROCEDURES



NOTE: REMOVAL OF THE FACTORY INSTALLED CALIBRATION SEALS AND/OR ANY ADJUSTMENTS MADE TO THE METER, AS DESCRIBED IN THIS SECTION, WILL VOID ANY CALIBRATION WARRANTY APPLICABLE.

7.1 Flow Calibration

Aalborg® Instruments' Flow Calibration Laboratory offers professional calibration support for Mass Flow Meters, using precision calibrators under strictly controlled conditions. NIST traceable calibrations are available. Calibrations can also be performed at customers' site using available standards. Factory calibrations are performed using NIST traceable precision volumetric calibrators incorporating liquid sealed frictionless actuators. Generally, calibrations are performed using dry nitrogen gas. The calibration can then be corrected to the appropriate gas desired based on relative correction [K] factors shown in the gas factor table (see APPENDIX III). A reference gas, other than nitrogen, may be used to better approximate the flow characteristics of certain gases. This practice is recommended when a reference gas is found with thermodynamic properties similar to the actual gas under consideration. The appropriate relative correction factor should be recalculated (see section 9). It is standard practice to calibrate Mass Flow Meters with dry nitrogen gas at 70.0 °F (21.1 °C), 20 psia (137.9 kPa absolute) inlet pressure and 0 psig outlet pressure. It is best to calibrate DFM transducers to actual operating conditions. Specific gas calibrations of non-toxic and non-corrosive gases are available at specific conditions. Please contact your distributor or Aalborg® for a price quotation.

It is recommended that a flow calibrator of at least four times better collective accuracy than that of the Mass Flow Meter to be calibrated be used. Equipment required for calibration includes: a flow calibration standard, PC with available RS-485/RS-232 communication interface, a certified high sensitivity multi meter (for

analog output calibration only), an insulated (plastic) screwdriver, a flow regulator (for example - metering needle valve) installed upstream from the Mass Flow Meter and a pressure regulated source of dry filtered nitrogen gas (or other suitable reference gas). It is recommended to use Aalborg® supplied calibration and maintenance software to simplify the calibration process. Gas and ambient temperature, as well as inlet and outlet pressure conditions should be set up in accordance with actual operating conditions.

7.2 Gas Flow Calibration of DFM Mass Flow Meters



All adjustments in this section are made from the outside of the meter via digital communication interface between a PC (terminal) and DFM. There is no need to disassemble any part of the instrument or perform internal PCB component (potentiometers) adjustment.

DFM Mass Flow Meters may be field recalibrated/checked for the same range they were originally factory calibrated for. When linearity adjustment is needed, or flow range changes are being made proceed to step 7.2.3. Flow range changes may require a different Restrictor Flow Element (RFE). Consult your distributor or Aalborg® for more information.

7.2.1 Connections and Initial Warm Up

Power up the Mass Flow Meter for at least 30 minutes prior to commencing the calibration procedure. Establish digital RS-485/RS-232 communication between PC (communication terminal) and the DFM. Start Aalborg® supplied calibration and maintenance software on the PC.

7.2.2 ZERO Check/Adjustment

Check SENSOR AVERAGE counts on the DFM LCD status line. Keep pressing the (▲) [Up] button from the main screen until status line will display Device Sensor Average ADC counts. With no flow conditions the sensor Average reading must be in the range 120 ± 10 counts. If it is not, perform Auto Zero procedure (see section 5.3.10 "Zero Calibration").

7.2.3 Gas Linearization Table Adjustment



Note: Your DFM Digital Mass Flow Meter was calibrated at the factory for the specified gas and full scale flow range (see device front label). There is no need to adjust the gas linearization table unless linearity adjustment is needed, flow range has to be changed, or new additional calibration is required. Any alteration of the gas linearization table will void calibration warranty supplied with instrument!

Gas flow calibration parameters are stored in the Gas Dependent portion of the EEPROM memory separately for each of 10 calibration tables. See APPENDIX I for complete list of gas dependent variables.



Note: Make sure the correct gas number and name is selected as current on the main DFM screen. All adjustments made to the gas linearization table will be applied to the currently selected gas.

The DFM gas flow calibration involves building of the table of the actual flow values (indexes 114, 116, 118, 120, 122, 124, 126, 128, 130, 132, 134) and corresponding sensor readings (indexes 113, 115, 117, 119, 121, 123, 125, 127, 129, 131, 133). Actual flow values are entered in normalized fraction format: 100.000 % F.S. corresponds to 1.000000 flow value and 0.000 % F.S. corresponds to 0.000000 flow value. The valid range for flow values is from 0.000000 to 1.000000 (note: DFM will accept up to 6 digits after decimal point). Sensor readings are entered in counts of 12 bits ADC output and should always be in the range of 0 to 4095. There are 11 elements in the table so the data should be obtained at increment 10.0 % of full scale (0.0, 10.0, 20.0, 30.0, 40.0, 50.0, 60.0, 70.0, 80.0, 90.0 and 100.0 % F.S.).



Note: Do not alter memory index 113 (must be 120 counts) and 114 (must be 0.0). These numbers represent zero flow calibration point and should not be changed.

If a new gas table is going to be created, it is recommended to start calibration from 100% full scale. If only linearity adjustment is required, calibration can be started in any intermediate portion of the gas table. Using the flow regulator, adjust the flow rate to 100% of full scale flow. Check the flow rate indicated against the flow calibrator. Observe flow reading on the DFM. If the difference between calibrator and DFM flow reading is more than 0.5% F.S., make a correction in the sensor reading in the corresponding position of the linearization table (Index 133). If the DFM flow reading is more than the calibrator reading, the number of counts in the index 133 has to be decreased. If the DFM flow reading is less than the calibrator reading, the number of counts in the index 133 has to be increased. Once Index 133 is adjusted with a new value, check the DFM flow rate against the calibrator and if required perform additional adjustments for Index 133. If a simple communication terminal is used for communication with the DFM, then "MW" (Memory Write) command from the software interface commands set may be used to adjust sensor value in the linearization table (see section 8.3 for complete software interface commands list). Memory Read "MR" command can be used to read the current value of the index. Assuming the DFM is configured with RS-485 interface and has address "11", the following example will first read the existing value of Index 133 and then write a new adjusted value:

!11,MR,133[CR] - reads EEPROM address 133

!11,MW,133,3450[CR] - writes new sensor value (3450 counts) in to the index 133

Once 100% F.S. calibration is completed user can proceed with calibration for another 9 points of the linearization table using the same approach.



Note: It is recommended to use Aalborg® supplied calibration and maintenance software for gas table calibration. This software includes an automated calibration procedure which may radically simplify reading and writing in to the EEPROM linearization table.

7.3 Analog output Calibration of DFM Mass Flow Meters

DFM series Mass Flow Meters are equipped with calibrated 0-5 Vdc (0-10 Vdc optional) and 4-20 mA output signals. The set of the jumpers (J2, J3, J4) on the analog printed circuit board is used to switch between 0-5 Vdc, 0-10 Vdc or 4-20 mA output signals (see APPENDIX IV).



Note: All analog outputs available on the DFM Digital Mass Flow Meter were calibrated at the factory for the specified gas and full scale flow range (see device front label). There is no need to perform analog output calibration unless the analog PC board was replaced or off set/span adjustment is needed. Any alteration of the analog output scaling variables in the Gas independent table will void calibration warranty supplied with instrument!



Note: It is recommended to use the Aalborg® supplied calibration and maintenance software for analog output calibration. This software includes an automated calibration procedure which may radically simplify calculation of the offsets and spans variables and reading and writing in to the EEPROM table.

The DFM analog output calibration involves calculation and storing of the offset and span variables in to the EEPROM for each available output. The 0-5 Vdc and 0-10 Vdc outputs have only scale variable and 20 mA outputs have offset and scale variables. The following is a list of the Gas independent variables used for analog output computation:

GAS FLOW

- 26 FlowOutScaleV - DAC 0-5/0-10 Analog Output Scale for Flow
- 27 FlowOutScale_mA - DAC 4-20mA Analog Output Scale for Flow
- 28 FlowOutOffset_mA - DAC 4-20mA Analog Output Offset for Flow

GAS TEMPERATURE

- 29 TempOutScaleV - DAC 0-5/0-10 Analog Output Scale for Temperature
- 30 TempOutScale_mA - DAC 4-20mA Analog Output Scale for Temperature
- 31 TempOutOffset_mA - DAC 4-20mA Analog Output Offset for Temperature

GAS PRESSURE

- 32 PresOutScaleV - DAC 0-5/0-10 Analog Output Scale for Pressure
- 33 PresOutScale_mA - DAC 4-20mA Analog Output Scale for Pressure



Note: Models DFM 26/36/46 do not support temperature and pressure measurement and have only one gas flow analog output.

7.3.1 Initial Setup

Power up the Mass Flow Meter for at least 3 minutes prior to commencing the calibration procedure. Make sure absolutely no flow takes place through the meter. Establish digital RS-485/RS-232 communication between PC (communication terminal) and DFM. The commands provided below assume that calibration will be performed manually (w/o Aalborg® supplied calibration and maintenance software) and the device has RS-485 address 11. If Aalborg® supplied calibration and maintenance software is used, skip the next section and follow prompts from the software.

Enter Backdoor mode by typing: !11,MW,1000,1[CR]
Unit will respond with: !11,BackDoorEnabled: Y
Disable DAC update by typing: !11,WRITE,4,D[CR]
Unit will respond with: !11,DisableUpdate: D

7.3.2 Gas flow 0-5 Vdc analog output calibration

1. Install jumpers J2 on the analog PC board for 0-5 Vdc output (see Table VI).
2. Connect a certified high sensitivity multi meter set for the voltage measurement to the pins 2 (+) and 15 (-) of the 25 pins D connector.
3. Write 4000 counts to the DAC channel 1: !11,WRITE,1,4000[CR]
4. Read voltage with the meter and calculate:

$$\text{FlowOutScaleV} = \frac{20000}{\text{Reading[V]}}$$

5. Save FlowOutScaleV in to the EEPROM: !11,MW,26,X[CR]
Where: X - the calculated FlowOutScaleV value.

7.3.3 Gas flow 4-20 mA analog output calibration

1. Install jumpers J2 on the analog PC board for 4-20 mA output (see Table VI).
2. Connect a certified high sensitivity multi meter set for the current measurement to pins 2 (+) and 15 (-) of the 25 pins D connector.
3. Write 4000 counts to the DAC channel 1: !11,WRITE,1,4000[CR]
4. Read current with the meter and calculate:
5. Write zero counts to the DAC channel 1: !11,WRITE,1,0CR]

$$\text{FlowOutScale_mA} = \frac{4000}{\text{Reading[mA]}}$$

6. Read offset current with the meter and calculate:

$$\text{FlowOutOffset_mA} = -\text{FlowOutScale_mA} * \text{Offset_Reading[mA]}$$

7. Save FlowOutScale_mA in to the EEPROM: !11,MW,27,Y[CR]

Save FlowOutOffset_mA in to the EEPROM: !11,MW,28,Z[CR]

Where: Y - the calculated FlowOutScale_mA value.
Z - the calculated FlowOutOffset_mA value.

7.3.4 Gas temperature 0-5 Vdc analog output calibration (DFM 27/37/47)

1. Install jumpers J3 on the analog PC board for 0-5 Vdc output (see Table VI).
2. Connect a certified high sensitivity multi-meter set for the voltage measurement to the pins 3 (+) and 16 (-) of the 25 pin D connector.
3. Write 4000 counts to the DAC channel 2: !11,WRITE,2,4000[CR]
4. Read voltage with the meter and calculate:

$$\text{TempOutScaleV} = \frac{20000}{\text{Reading[V]}}$$

5. Save TempOutScaleV in to the EEPROM: !11,MW,29,X[CR]

Where: X - the calculated TempOutScaleV value.

7.3.5 Gas temperature 4-20 mA analog output calibration (DFM 27/37/47)

1. Install jumpers J3 on the analog PC board for 4-20 mA output (see Table VI).
2. Connect a certified high sensitivity multi-meter set for the current measurement to the pins 3 (+) and 16 (-) of the 25 pins D connector.
3. Write 4000 counts to the DAC channel 2: !11,WRITE,2,4000[CR]
4. Read current with the meter and calculate:

$$\text{TempOutScale_mA} = \frac{4000}{\text{Reading[mA]}}$$

5. Write zero counts to the DAC channel 2: !11,WRITE,2,0CR]
6. Read offset current with the meter and calculate:
7. Save TempOutScale_mA in to the EEPROM: !11,MW,30,Y[CR]
Save TempOutOffset_mA in to the EEPROM: !11,MW,31,Z[CR]

Where: Y - the calculated TempOutScale_mA value.
Z - the calculated TempOutOffset_mA value.

7.3.6 Gas pressure 0-5 Vdc analog output calibration (DFM 27/37/47)

1. Install jumpers J4 on the analog PC board for 0-5 Vdc output (see Table VI).
2. Connect a certified high sensitivity multi-meter set for the voltage measurement to the pins 4 (+) and 17 (-) of the 25 pin D connector.
3. Write 4000 counts to the DAC channel 3: !11,WRITE,3,4000[CR]

$$\text{PresOutScaleV} = \frac{20000}{\text{Reading[V]}}$$

4. Read voltage with the meter and calculate:
5. Save PresOutScaleV in to the EEPROM: !11,MW,32,X[CR]
Where: X - the calculated PresOutScaleV value.

7.3.7 Gas pressure 4-20 mA analog output calibration (DFM 27/37/47)

1. Install jumpers J4 on the analog PC board for 4-20 mA output (see Table VI).
2. Connect a certified high sensitivity multi-meter set for the current measurement to the pins 4 (+) and 17 (-) of the 25 pin D connector.
3. Write 4000 counts to the DAC channel 3: !11,WRITE,3,4000[CR]
4. Read current with the meter and calculate:

$$\text{PresOutScale_mA} = \frac{4000}{\text{Reading[mA]}}$$

5. Write zero counts to the DAC channel 3: !11,WRITE,3,0CR]
6. Read offset current with the meter and calculate:
7. Save PresOutScale_mA in to the EEPROM: !11,MW,33,Y[CR]
Save PresOutOffset_mA in to the EEPROM: !11,MW,34,Z[CR]

Where: Y - the calculated PresOutScale_mA value.
Z - the calculated PresOutOffset_mA value.



Note: When done with the analog output calibration make sure the DAC update is enabled and the BackDoor is closed (see command below).

Enable DAC update by typing: !11,WRITE,4,N[CR]
Unit will respond with: !11,DisableUpdate: N

Close Backdoor mode by typing: !11,MW,1000,0[CR]
Unit will respond with: !11,BackDoorEnabled: N

7.4 Temperature or/and Pressure sensor Calibration

Calibration of the temperature and pressure sensors for DFM 27/37/47 devices is not described in this manual. Temperature or/and pressure sensors re-calibration requires factory assistance.

8. RS-485/RS-232 SOFTWARE INTERFACE COMMANDS

8.1 General

The standard DFM comes with an RS-485 interface. For the optional RS-232 interface the start character (!) and two hexadecimal characters for the address have to be omitted. The protocol described below allows for communications with the

unit using either a custom software program or a "dumb terminal." All values are sent as printable ASCII characters. For RS-485 interface the start character is always (!), and the command string is terminated with a carriage return (line feeds are automatically stripped out by the DFM). See section 2.2.3 for information regarding communication parameters and cable connections.

8.2 Commands Structure

The structure of the command string:

!<Addr>,<Cmd>,<Arg1>,<Arg2>,<Arg3>,<Arg4><CR>

Where:

!	Start character **
Addr	RS485 device address in the ASCII representation of hexadecimal (00 through FF are valid).**
Cmd	The one or two character command from the table below.
Arg1 to Arg4	The command arguments from the table below. Multiple arguments are comma delimited.
CR	Carriage Return character.

** Default address for all units is 11. Do not submit start character and two character hexadecimal device address for RS-232 option.

Several examples of commands follow. All assume that the DFM has been configured for address 15 (0F hex) on the RS485 bus:

1. To get the temperature reading: !0F,TR<CR>

The DFM will reply: !0F72.5 F<CR> >
(Assuming temperature is 72.5F)

2. To get the pressure reading: !0F,PR<CR>

The DFM will reply: !0F14.5 PSI<CR> >
(Assuming pressure is 14.5 PSI)

3. To get a flow reading: !0F,F<CR>

The DFM will reply: !0F50.0<CR>
(Assuming the flow is at 50%F.S.)

4. Set the high alarm limit to 85% F.S.: !0F,A,H,85.0<CR>

The DFM will reply: !0FAH85.0<CR>



Note: Address 00 is reserved for global addressing. Do not assign global address for any device. When command with global address is sent, all devices on the RS-485 bus execute the command, but do not reply with acknowledge message.

The global address can be used to change RS-485 address for a particular device with unknown address:

1. **Make sure only one device (which address has to be changed) is connected to the RS-485 network.**
2. **Type the memory write command with global address:
!00,MW,7,XX[CR]**

**where XX, the new hexadecimal address can be [01 - FF].
After assigning the new address a device will accept commands with the new address.**



Note: Do not assign the same RS-485 address for two or more devices on the same RS-485 bus. If two or more devices with the same address are connected to the one RS-485 network, the bus will be corrupted and communication errors will occur.

8.3 ASCII Commands Set

AALBORG DFM SOFTWARE INTERFACE COMMANDS

NOTE: AN "*" INDICATES POWER UP DEFAULT SETTINGS.

AN "***" INDICATES OPTIONAL FEATURE NOT AVAILABLE ON ALL MODELS.

COMMAND NAME	DESCRIPTION	NO.	COMMAND SYNTAX					
			COMMAND	ARGUMENT 1	ARGUMENT 2	ARGUMENT 3	ARGUMENT 4	RESPONSE
Flow	Requests the current flow sensor reading	1	F					<Value> (Actual flow in current engineering units)
Temperature reading	Requests the current temperature sensor reading (** if supported by hardware)	2	TR					<Value> (Actual temperature in current engineering units)
Pressure reading	Requests the current pressure sensor reading (** if supported by hardware)	3	PR					<Value> (Actual pressure in current engineering units)
Gas Select	Selects one of the ten primary gas calibration tables to use. Tables are entered via the MEM commands at time of calibration.	4	G	T (set gas table)	0 (gas 0) to 9 (gas 9)			GT0 through GT9
				S (status)				GS0 through GS9 <Gas Name>
Auto Zero	Starts /reads the status of the auto zero feature (Note: The Z,N command can be used only when absolutely no flow takes place through the meter. It can take several minutes to complete. Unit will not respond to other commands when this is in progress.)	5	Z	N (do it now)				ZN
				W (Write Zero to EEPROM)				ZW (when done)
				S (status while auto zero in progress)				ZN, <value> while Z,N is in progress.
				V (Display zero value)				ZV, <zero value>

COMMAND SYNTAX								
COMMAND NAME	DESCRIPTION	NO.	COMMAND	ARGUMENT 1	ARGUMENT 2	ARGUMENT 3	ARGUMENT 4	RESPONSE
Flow Alarms	Sets / reads the status of the gas flow alarms. Note: High and Low limits have to be entered in the %FS. High alarm value has to be more than Low alarm value. Alarm conditions: Flow > High Limit = H Flow < Low Limit = L Low < Flow < High = N	6	A	H (high flow limit) L (low flow limit) A (action delay in seconds) E (enable alarm) D (disable alarm) R (read status) S (set. status)	<Value> <Value> <Value> (0-3600 sec.)			AH<Value> AL<Value> AA<Value> AE AD N (no alarm) H (high alarm) L (low alarm) AS:M,L,H,D
Temperature Alarms	Sets / reads the status of the temperature alarms. Note: High and Low limits have to be entered in °C. High alarm value has to be more than Low alarm value. Alarm conditions: Temp. > High Limit = H Temp. < Low Limit = L Low < Temp. < High = N (* if supported by hardware)	7	TA	H (high limit) L (low limit) E (enable alarm) D (disable alarm) R (read status) S (set. status)	<Value> <Value>			TAH<Value> TAL<Value> TAE TAD N (no alarm) H (high alarm) L (low alarm) TAS:M,L,H

COMMAND SYNTAX								
COMMAND NAME	DESCRIPTION	NO.	COMMAND	ARGUMENT 1	ARGUMENT 2	ARGUMENT 3	ARGUMENT 4	RESPONSE
Pressure Alarms	Sets /reads the status of the pressure alarms. Note: High and Low limits have to be entered in PSI High alarm value has to be more than Low alarm value. Alarm conditions: Temp. > High Limit = H Temp. < Low Limit = L Low < Temp. < High = N (* * if supported by hardware)	8	PA	H (high limit)	<Value>			PAH<Value>
				L (low limit)	<Value>			PAL<Value>
				E (enable alarm)				PAE
				D (disable alarm)				PAD
				R (read status)				N (no alarm) H (high alarm) L (low alarm)
				S (set. status)				PAS:M,L,H
Relay Action	Assigns action of the two SPDT relays. The coil is energized when the condition specified by "Argument 2" becomes true.	9	R	1 (relay 1)	N (no action, relay disabled) *			RN
				2 (relay 2)	T (totalizer reading > limit)			RT
					H (high flow alarm)			RH
					L (low flow alarm)			RL
					R (Range High & Low alarm)			RR
					A (high Temp.)			RA
					B (low Temp.)			RB
					C (high Press.)			RC
					D (low Press.)			RD
					S (status)			RxN, RxT, RxH, RxL, RxR, RxA, RxB, RxC, RxD

COMMAND NAME	DESCRIPTION	NO.	COMMAND SYNTAX						
			COMMAND	ARGUMENT 1	ARGUMENT 2	ARGUMENT 3	ARGUMENT 4	RESPONSE	
Totalizer	Controls action of the flow totalizer.	10	T	Z (Reset to zero)					TZ
			F (start totalizer at flow %F.S.)	<value> (gas flow %FS)				TF<value>	
			L (Limit volume in current E.U.)	<value> (gas volume)				TL<value>	
			D (stop the totalizer)					TD	
			E (run the totalizer)					TE	
			R (read the totalizer)					<value>	
			S (setting status)					TS:M, Start,Limit	
			D (disable, sets K=1)					KD	
			I (internal K factor table index)	<value> index from internal table [0-31]				KI<value> <value> = [0-31]	
			U (user specified factor)	<value> (decimal correction factor)				KU<value>	
K Factors	Applies a gas correction factor to the currently selected primary gas calibration table. (Note: does not work with % F.S. engineering unit.)	11	K	S (status)					K<value>

COMMAND NAME	DESCRIPTION	NO.	COMMAND SYNTAX						
			COMMAND	ARGUMENT 1	ARGUMENT 2	ARGUMENT 3	ARGUMENT 4	RESPONSE	
Units	Sets the units of measure for the flow signal and totalizer. Note: The units of the totalizer output are not per unit time.	12	U	%(%full scale)* L/min (liters per min.) L/h (liters per hr.) mL/min (milliliters per min) mL/h (milliliters per hr.) CFH (cubic feet per hour) CFM (cubic feet per min.) LBPH (pounds per hour) LBPM (pounds per min.) UD (user defined)					U% UL/min UL/h UmL/min UmL/h UCFH UCFM ULBPH ULBPM
Maintenance Timer	Hours since last time unit was calibrated.	13	C	S <status> Returns current flow EU. R (read timer) C (set timer to zero)	<value> (conversion factor from SLPm)	S - seconds M - minutes H - hours (Time base)	Y - use density N - do not use density	UUD<value><value><value> U<value> <value> CC	

COMMAND NAME	DESCRIPTION	NO.	COMMAND SYNTAX					RESPONSE
			COMMAND	ARGUMENT 1	ARGUMENT 2	ARGUMENT 3	ARGUMENT 4	
Full Scale	Returns the full scale rated flow in L/min. (Note: This term is not multiplied by the current K factor)	14	E					<value>
Flow Conditions	Set STD or ACTUAL Flow conditions	15	FC	T - STD A - ACTUAL S - Status				FC STD FC ACTUAL FC STD
Read Memory	Reads the value in the specified memory location.	16	MR	0000 to 999 (Table Index)				<value>
Write Memory	Writes the specified value to the specified memory location. Use carefully, can cause unit to malfunction.	17	MW	0000 to 999 (Table Index)				MWXXX<value> XXX=Table Index

UART Error Codes:

- 1- BackDoor is not enabled
- 2- Wrong number of Arguments
- 3- Hardware for requested function is not installed (not available).
- 4- Wrong number of the characters in the Argument.
- 5- Attempt to Alter Write Protected Area in the EEPROM.
- 6- Proper Command or Argument is not found.
- 7- Wrong value of the Argument.
- 8- Wrong Command.
- 9- Reserved.
- 10- Argument out of range.
- 11- Auto ZERO in Progress

9. TROUBLESHOOTING

9.1 Common Conditions

Your DFM Digital Mass Flow Meter was thoroughly checked at numerous quality control points during and after manufacturing and assembly operations. It was calibrated according to your desired flow and pressure conditions for a given gas or a mixture of gases. It was carefully packed to prevent damage during shipment. Should you feel that the instrument is not functioning properly please check for the following common conditions first:

Are all cables connected correctly?

Are there any leaks in the installation?

Is the power supply correctly selected according to requirements?

When several meters are used a power supply with appropriate current rating should be selected.

Were the connector pinouts matched properly?

When interchanging with other manufacturers' equipment, cables and connectors must be carefully wired for correct pin configurations.

Is the pressure differential across the instrument sufficient?

NO.	INDICATION	LIKELY REASON	SOLUTION
1	No zero reading after 15 min. warm up time and no flow condition.	Embedded temperature has been changed.	Perform Auto Zero Procedure (see section 5.3.10 "Zero Calibration").
2	LCD Display remains blank when unit is powered up. No response when flow is introduced from analog outputs 0-5 Vdc or 4-20 mA.	Power supply is bad or polarity is reversed.	<p><u>For 12 or 24 Vdc option:</u> Measure voltage on pins 1 and 18 of the 25 pin D-connector. If voltage is out of specified range, then replace power supply with a new one. If polarity is reversed (reading is negative) make correct connection.</p> <p><u>For ±15Vdc option:</u> Measure voltage on pins 1-18 and 14-18 of the 25 pin D-connector. If voltage is out of specified range, then replace power supply with a new one. If polarity is reversed (reading is negative) make correct connection.</p>
		PC board is defective.	Return DFM to factory for repair.
3	LCD Display reading or /and analog output 0-5Vdc signal fluctuate in wide range during flow measurement.	Output 0-5 Vdc signal (pins 2-15, 3-16, 4-17 of the D-connector) is shorted on the GND or overloaded.	Check external connections to pins 2-15, 3-16, 4-17 of the D-connector. Make sure the load resistance is more than 1000 Ohm.
4	LCD Display reading does correspond to the correct flow range, but 0-5 Vdc output signal does not change (always the same reading or around zero).	Output 0-5Vdc schematic is burned out or damaged.	Return DFM to factory for repair.
		Analog flow output scale and offset variable are corrupted.	Restore original EEPROM scale and offset variable or perform analog output recalibration (see section 7.3).
5	LCD Display reading and 0-5 Vdc output voltage do correspond to the correct flow range, but 4-20 mA output signal does not change (always the same or reading around 4.0 mA).	External loop resistance is open or more than 500 Ohm.	Check external connections to pins 2 and 15 of the D-connector. Make sure the loop resistance is less than 500 Ohm.
		Output 4-20 mA schematic is burned out or damaged.	Return DFM to factory for repair.
6	Calibration is off (more than 1.0 % F.S.).	DFM has initial zero shift.	Shut off the flow of gas into the DFM (ensure gas source is disconnected and no seepage or leak occurs into the meter). Wait for 15 min. with no flow condition and perform Auto Zero calibration Procedure (see section 5.3.10 "Zero Calibration").
7	LCD Display reading is above maximum flow range and output voltage 0-5 Vdc signal is more than 5.0 Vdc when gas flows through the DFM.	Sensor under swamping conditions (flow is more than 10% above maximum flow rate for particular DFM).	Lower the flow through DFM within calibrated range or shut down the flow completely. The swamping condition will end automatically.
		PC board is defective.	Return DFM to factory for repair.

NO.	INDICATION	LIKELY REASON	SOLUTION
8	Gas flows through the DFM, but LCD Display reading and The output voltage 0-5 Vdc signal do not respond to flow.	The gas flow is too low for particular model of DFM.	Check maximum flow range on transducer's front panel and make required flow adjustment.
		<u>DFM26/27 models:</u> RFE is not connected properly to the inlet fitting.	Unscrew the inlet compression fitting of the meter and reinstall RFE (see section 6.2.2). Note: Calibration accuracy can be affected.
		<u>DFM36/37/46/47 models:</u> RFE is shifted and blocked the sensor.	Unscrew the four socket head cap screws at the inlet side of the meter. Reinstall RFE and retaining ring (see section 6.2.3). Note: Calibration accuracy can be affected.
		Sensor or PC board is defective.	Return DFM to factory for repair.
9	Gas does not flow through the DFM with inlet pressure applied to the inlet fitting. LCD Display reading and output voltage 0-5 Vdc signal show zero flow.	Filter screen obstructed at inlet.	Flush clean or disassemble to remove impediments or replace the filter screen (see section 6.2). Note: Calibration accuracy can be affected.
		Direction of the gas flow is reversed.	Check the direction of gas flow as indicated by the arrow on the front of the meter and make required reconnection in the installation.
		DFM is connected in the installation with back pressure conditions and gas leak exist in the system.	Locate and correct gas leak in the system. If DFM has internal leak return it to factory for repair.
10	Gas flows through the DFM, but LCD Display reading is negative and output voltage 0-5 Vdc signal does not respond to flow (reading near 1mV).	Direction of the gas flow is reversed.	Check the direction of gas flow as indicated by the arrow on the front of the meter and make required reconnection in the installation.
		DFM is connected in the installation with back pressure conditions and gas leak exist in the system.	Locate and correct gas leak in the system. If DFM has internal leak return it to factory for repair.
11	DFM is disconnected from the source of the gas (no flow conditions) but LCD Display reading is fluctuating in wide range. Output voltage 0-5 Vdc signal also fluctuating. The power supply voltage is within specification and stable.	Sensor or PC board is defective.	Return DFM to factory for repair.

9.3 Technical Assistance

Aalborg Instruments will provide technical assistance over the phone to qualified repair personnel. Please call our Technical Assistance at 845-770-3000. Please have your Serial Number and Model Number ready when you call.

10. CALIBRATION CONVERSIONS FROM REFERENCE GASES

The calibration conversion incorporates the K factor. The K factor is derived from gas density and coefficient of specific heat. For diatomic gases:

$$K_{\text{gas}} = \frac{1}{d \times C_p}$$

where d = gas density (gram/liter)

C_p = coefficient of specific heat (cal/gram)

Note in the above relationship that d and C_p are usually chosen at standard conditions of one atmosphere and 25° C.

If the flow range of a Mass Flow Controller or Controller remains unchanged, a relative K factor is used to relate the calibration of the actual gas to the reference gas.

$$K = \frac{Q_a}{Q_r} = \frac{K_a}{K_r}$$

where Q_a = mass flow rate of an actual gas (sccm)

Q_r = mass flow rate of a reference gas (sccm)

K_a = K factor of an actual gas

K_r = K factor of a reference gas

For example, if we want to know the flow rate of oxygen and wish to calibrate with nitrogen at 1000 SCCM, the flow rate of oxygen is:

$$Q_{O_2} = Q_a = Q_r \times K = 1000 \times 0.9926 = 992.6 \text{ sccm}$$

where K = relative K factor to reference gas (oxygen to nitrogen)

APPENDIX I
AALBORG® DFM EEPROM Variables Rev.A3 [12/05/2004]
Gas Independent Variables

INDEX	NAME	DATA TYPE	NOTES
0	BlankEEPROM	char[10]	Do not modify. Table Revision.
1	SerialNumber	char[20]	Serial Number
2	ModelNumber	char[20]	Model Number
3	SoftwareVer	char[10]	Firmware Version
4	TimeSinceCalHr	float	Time since last calibration in hours.
5	Options1	uint	Misc. Options*
6	Reserved2	char	Flow Conditions [0-STD, 1-ACTUAL]
7	AddressRS485	char[3]	Two character address for RS485 only
8	DigGasNumber	int	Current Gas Table Number [0-9]
9	FlowUnits	int	Current Units of Measure [0-10]
10	AlarmMode	char	Alarm Mode ['R'- Enabled, 'S' - Disabled]
11	LowAlarmPFS	float	Low Flow Alarm Setting [%FS] 0-Disabled
12	HiAlarmPFS	float	High Flow Alarm Setting [%FS] 0-Disabled
13	AlmDelay	uint	Flow Alarm Action Delay [0-3600sec] 0-Disabled
14	RelaySetting[0]	char	Relay #1 Assignment Setting (N, T, H, L, Range)
15	RelaySetting[1]	char	Relay #2 Assignment Setting (N, T, H, L, Range)
16	TotalMode	char	Totalizer Mode ['R'- Enabled, 'S' - Disabled]
17	Total	float	Totalizer Volume in %*s (updated every 6 min)
18	TotalFlowStart	float	Start Totalizer at flow [%FS] 0 - Disabled
19	TotalVolStop	float	Totalizer Action Limit Volume [%*s] 0-Disabled
20	KfactorIndex	int	Internal K-Factor Index [0-31]**
21	UserDefkfactor	float	User Defined K-Factor
22	UDUnitKfactor	float	K-Factor for User Defined Units of Measure
23	UDUnitTimeBase	int	User Defined Unit Time Base [1, 60, 3600 sec]
24	UDUnitDensity	char	User Defined Unit Density Flag [Y, N]
25	TPUnits	char	Temperature/Pressure Units [C (Bar), F (PSI)]
26	FlowOutScaleV	float	DAC 0-5/0-10 Analog Output Scale for Flow
27	FlowOutScale_mA	float	DAC 4-20mA Analog Output Scale for Flow
28	FlowOutOffset_mA	float	DAC 4-20mA Analog Output Offset for Flow
29	TempOutScaleV	float	DAC 0-5/0-10 Analog Output Scale for Temp.
30	TempOutScale_mA	float	DAC 4-20mA Analog Output Scale for Temp.
31	TempOutOffset_mA	float	DAC 4-20mA Analog Output Offset for Temp.
32	PresOutScaleV	float	DAC 0-5/0-10 Analog Output Scale for Pressure
33	PresOutScale_mA	float	DAC 4-20mA Analog Output Scale for Pressure
34	PresOutOffset_mA	float	DAC 4-20mA Analog Output Offset for Pressure

INDEX	NAME	DATA TYPE	NOTES
35	TAInScaleV	float	ADC Temp. Analog In Scale (0-5V)
36	TAInOffsetV	float	ADC Temp. Analog In Offset (0-5V)
37	PAInScaleV	float	ADC Pressure Analog In Scale (0-5V)
38	PAInOffsetV	float	ADC Pressure Analog In Offset (0-5V)
39	SensorZero	uint	D/A Value for Sensor Zero [0-4095 counts]
40	Klag [0]	float	DRC Lag Constant [Do Not Alter]
41	Klag [1]	float	DRC Lag Constant [Do Not Alter]
42	Klag [2]	float	DRC Lag Constant [Do Not Alter]
43	Klag [3]	float	DRC Lag Constant [Do Not Alter]
44	Klag [4]	float	DRC Lag Constant [Do Not Alter]
45	Klag [5]	float	DRC Lag Constant [Do Not Alter]
46	Reserved	float	
47	Reserved	float	
48	Reserved	float	
49	Reserved	float	
50	Reserved	float	
51	Reserved	float	
52	Kgain[0]	float	Gain for DRC Lag Constant [Do Not Alter]
53	Kgain[1]	float	Gain for DRC Lag Constant [Do Not Alter]
54	Kgain[2]	float	Gain for DRC Lag Constant [Do Not Alter]
55	Kgain[3]	float	Gain for DRC Lag Constant [Do Not Alter]
56	Kgain[4]	float	Gain for DRC Lag Constant [Do Not Alter]
57	Kgain[5]	float	Gain for DRC Lag Constant [Do Not Alter]
58	Reserved	float	
59	Reserved	float	
60	Reserved	float	
61	Reserved	float	
62	Reserved	float	
63	Reserved	float	
64	KfactorMode	char	K-Factor Mode: D-Dis'd, I-Internal, U-User Def'd
65	TmpAlarmMode	char	Temp. Alarm Mode ['R' - Enabled, 'S' - Disabled]
66	LowAlarmC	float	Low Temp. Alarm Setting [0-50 °C]
67	HiAlarmC	float	High Temp. Alarm Setting [0-50 °C]
68	PrsAlarmMode	char	Press. Alarm Mode ['R' - Enabled, 'S' - Disabled]
69	LowAlarmP	float	Low Press. Alarm Setting [0-100 PSI]
70	HiAlarmP	float	High Press. Alarm Setting [0-100 PSI]
71	Zero_T	float	Resistance when last AutoZero was done [Counts]
72	Tcor_K	float	Resistance correction coefficient [PFS/count]

Calibration Table: Gas Dependent Variables.

INDEX	NAME	DATA TYPE	NOTES
100	GasIdentifier	char[27]	Name of Gas [If not calibrated = "Uncalibrated"]
101	FullScaleRange	float	Full Scale Range in SLPm.
102	StdTemp	float	Standard Temperature
103	StdPressure	float	Standard Pressure
104	StdDensity	float	Gas Standard Density
105	CalibrationGas	char[27]	Name of Gas used for Calibration [If not calibrated="Uncalibrated"]
106	CalibratedBy	char[20]	Name of person who performed actual calibration
107	CalibratedAt	char[20]	Name of Calibration Facility
108	DateCalibrated	char[10]	Calibration Date
109	DateCalibrationDue	char[10]	Date Calibration Due
110	PID_Kp	float	Reserved
111	PID_Ki	float	Reserved
112	PID_Kd	float	Reserved
113	SensorTbl[0][Sensor Value]	uint	Index 0: Must be 120 (zero value) Do not Alter!
114	SensorTbl[0][Flow]	float	Index 0: Must be 0.0 (zero PFS) Do not Alter!
115	SensorTbl[1][Sensor Value]	uint	10.0%F.S. A/D value from sensor [counts].
116	SensorTbl[1][Flow]	float	Actual Flow in PFS [0.1].
117	SensorTbl[2][Sensor Value]	uint	20.0%F.S. A/D value from sensor [counts].
118	SensorTbl[2][Flow]	float	Actual Flow in PFS [0.2].
119	SensorTbl[3][Sensor Value]	uint	30.0%F.S. A/D value from sensor [counts].
120	SensorTbl[3][Flow]	float	Actual Flow in PFS [0.3].
121	SensorTbl[4][Sensor Value]	uint	40.0%F.S. A/D value from sensor [counts].
122	SensorTbl[4][Flow]	float	Actual Flow in PFS [0.4].
123	SensorTbl[5][Sensor Value]	uint	50.0%F.S. A/D value from sensor [counts].
124	SensorTbl[5][Flow]	float	Actual Flow in PFS [0.5].
125	SensorTbl[6][Sensor Value]	uint	60.0%F.S. A/D value from sensor [counts].
126	SensorTbl[6][Flow]	float	Actual Flow in PFS [0.6].
127	SensorTbl[7][Sensor Value]	uint	70.0%F.S. A/D value from sensor [counts].
128	SensorTbl[7][Flow]	float	Actual Flow in PFS [0.7].
129	SensorTbl[8][Sensor Value]	uint	80.0%F.S. A/D value from sensor [counts].
130	SensorTbl[8][Flow]	float	Actual Flow in PFS [0.8].
131	SensorTbl[9][Sensor Value]	uint	90.0%F.S. A/D value from sensor [counts].
132	SensorTbl[9][Flow]	float	Actual Flow in PFS [0.9].
133	SensorTbl[10][Sensor Value]	uint	100.0%F.S. A/D value from sensor [counts].
134	SensorTbl[10][Flow]	float	Flow in PFS. Should be 1.0 Do not Alter!

Note: Values will be available for selected gas only.

APPENDIX II INTERNAL "K" FACTORS

⚠ CAUTION: K-Factors at best are only an approximation. K factors should not be used in applications that require accuracy better than +/- 5 to 10%.

INDEX	ACTUAL GAS	K Factor Relative to N ₂	Cp [Cal/g]	DENSITY [g/l]
0	Air	1.0000	.240	1.293
1	Argon Ar	1.4573	.1244	1.782
2	Acetylene C ₂ H ₂	.5829	.4036	1.162
3	Ammonia NH ₃	.7310	.492	.760
4	Butane C ₄ H ₁₀	.2631	.4007	2.593
5	Chlorine Cl ₂	.86	.114	3.163
6	Carbon Monoxide C _o	1.00	.2488	1.250
7	Carbon Dioxide CO ₂	.7382	.2016	1.964
8	Chloroform CHCl ₃	.3912	.1309	5.326
9	Ethane C ₂ H ₆	.50	.420	1.342
10	Ethylene C ₂ H ₄	.60	.365	1.251
11	Freon-134A CF ₃ CH ₂ F	.5096	.127	4.224
12	Fluorine F ₂	.9784	.1873	1.695
13	Fluoroform (Freon-23) CHF ₃	.4967	.176	3.127
14	Helium He	1.454	1.241	.1786
15	Hydrogen H ₂	1.0106	3.419	.0899
16	Hydrogen Chloride HCl	1.000	.1912	1.627
17	Hydrogen Sulfide H ₂ S	.80	.2397	1.520
18	Hexane C ₆ H ₁₄	.1792	.3968	3.845
19	Methane CH ₄	.7175	.5328	.715
20	Neon NE	1.46	.246	.900
21	Nitrous Oxide N ₂ O	.7128	.2088	1.964
22	Nitrogen Dioxide NO ₂	.737	.1933	2.052
23	Nitric Oxide NO	.990	.2328	1.339
24	Nitrogen Trifluoride NF ₃	.4802	.1797	3.168
25	Oxygen O ₂	.9926	.2193	1.427
26	Ozone	.446	.195	2.144
27	Propane C ₃ H ₈	.35	.399	1.967
28	Propylene C ₃ H ₆	.40	.366	1.877
29	Sulfur Dioxide SO ₂	.69	.1488	2.858
30	Sulfur Hexafluoride SF ₆	.2635	.1592	6.516
31	Xenon Xe	1.44	.0378	5.858

APPENDIX III GAS FACTOR TABLE (“K FACTORS”)

⚠ CAUTION: K-Factors at best are only an approximation. K factors should not be used in applications that require accuracy better than +/- 5 to 10%.

INDEX	ACTUAL GAS	K Factor Relative to N ₂	Cp [Cal/g]	DENSITY [g/l]
0	Acetylene C ₂ H ₂	.5829	.4036	1.162
1	Air	1.0000	.240	1.293
2	Allene (Propadiene) C ₃ H ₄	.4346	.352	1.787
3	Ammonia NH ₃	.7310	.492	.760
4	Argon Ar (<=10 L/min)	1.4573	.1244	1.782
	Argon AR-1 (>=10 L/min)	1.205	.1244	1.782
5	Arsine AsH ₃	.6735	.1167	3.478
6	Boron Trichloride BCl ₃	.4089	.1279	5.227
7	Boron Trifluoride BF ₃	.5082	.1778	3.025
8	Bromine Br ₂	.8083	.0539	7.130
9	Boron Tribromide Br ₃	.38	.0647	11.18
10	Bromine PentaTrifluoride BrF ₅	.26	.1369	7.803
11	Bromine Trifluoride BrF ₃	.3855	.1161	6.108
12	Bromotrifluoromethane (Freon-13 B1) CBrF ₃	.3697	.1113	6.644
13	1,3-Butadiene C ₄ H ₆	.3224	.3514	2.413
14	Butane C ₄ H ₁₀	.2631	.4007	2.593
15	1-Butene C ₄ H ₈	.2994	.3648	2.503
16	2-Butene C ₄ H ₈ CIS	.324	.336	2.503
17	2-Butene C ₄ H ₈ TRANS	.291	.374	2.503
18	Carbon Dioxide CO ₂ (<10 L/min)	.7382	.2016	1.964
	Carbon Dioxide CO ₂ -1 (>10 L/min)	.658	.2016	1.964
19	Carbon Disulfide CS ₂	.6026	.1428	3.397
20	Carbon Monoxide CO	1.00	.2488	1.250
21	Carbon Tetrachloride CCl ₄	.31	.1655	6.860
22	Carbon Tetrafluoride (Freon-14)CF ₄	.42	.1654	3.926
23	Carbonyl Fluoride COF ₂	.5428	.1710	2.945
24	Carbonyl Sulfide COS	.6606	.1651	2.680
25	Chlorine Cl ₂	.86	.114	3.163
26	Chlorine Trifluoride ClF ₃	.4016	.1650	4.125
27	Chlorodifluoromethane (Freon-22)CHClF ₂	.4589	.1544	3.858
28	Chloroform CHCl ₃	.3912	.1309	5.326
29	Chloropentafluoroethane(Freon-115)C ₂ ClF ₅	.2418	.164	6.892
30	Chlorotrifluoromethane (Freon-13) CClF ₃	.3834	.153	4.660
31	CyanogenC ₂ N ₂	.61	.2613	2.322
32	CyanogenChloride ClCN	.6130	.1739	2.742

INDEX	ACTUAL GAS	K Factor Relative to N ₂	Cp [Cal/g]	DENSITY [g/l]
33	Cyclopropane C ₃ H ₅	.4584	.3177	1.877
34	Deuterium D ₂	1.00	1.722	1.799
35	Diborane B ₂ H ₆	.4357	.508	1.235
36	Dibromodifluoromethane CBr ₂ F ₂	.1947	.15	9.362
37	Dichlorodifluoromethane (Freon-12) CCl ₂ F ₂	.3538	.1432	5.395
38	Dichlorofluoromethane (Freon-21) CHCl ₂ F	.4252	.140	4.592
39	Dichloromethylsilane (CH ₃) ₂ SiCl ₂	.2522	.1882	5.758
40	Dichlorosilane SiH ₂ Cl ₂	.4044	.150	4.506
41	Dichlorotetrafluoroethane (Freon-114) C ₂ Cl ₂ F ₄	.2235	.1604	7.626
42	1,1-Difluoroethylene (Freon-1132A) C ₂ H ₂ F ₂	.4271	.224	2.857
43	Dimethylamine (CH ₃) ₂ NH	.3714	.366	2.011
44	Dimethyl Ether (CH ₃) ₂ O	.3896	.3414	2.055
45	2,2-Dimethylpropane C ₃ H ₁₂	.2170	.3914	3.219
46	Ethane C ₂ H ₆	.50	.420	1.342
47	Ethanol C ₂ H ₆ O	.3918	.3395	2.055
48	Ethyl Acetylene C ₄ H ₆	.3225	.3513	2.413
49	Ethyl Chloride C ₂ H ₅ Cl	.3891	.244	2.879
50	Ethylene C ₂ H ₄	.60	.365	1.251
51	Ethylene Oxide C ₂ H ₄ O	.5191	.268	1.965
52	Fluorine F ₂	.9784	.1873	1.695
53	Fluoroform (Freon-23) CHF ₃	.4967	.176	3.127
54	Freon-11 CCl ₃ F	.3287	.1357	6.129
55	Freon-12 CCl ₂ F ₂	.3538	.1432	5.395
56	Freon-13 CClF ₃	.3834	.153	4.660
57	Freon-13B1 CBrF ₃	.3697	.1113	6.644
58	Freon-14 CF ₄	.4210	.1654	3.926
59	Freon-21 CHCl ₂ F	.4252	.140	4.592
60	Freon-22 CHClF ₂	.4589	.1544	3.858
61	Freon-113 CCl ₂ FCClF ₂	.2031	.161	8.360
62	Freon-114 C ₂ Cl ₂ F ₄	.2240	.160	7.626
63	Freon-115 C ₂ ClF ₅	.2418	.164	6.892
64	Freon-C318 C ₄ F ₈	.1760	.185	8.397
65	Germane GeH ₄	.5696	.1404	3.418
66	Germanium Tetrachloride GeCl ₄	.2668	.1071	9.565
67	Helium He (<50 L/min)	1.454	1.241	.1786
	Helium He-1 (>50 L/min)	2.43	1.241	.1786
	Helium He-2 (>10-50 L/min)	2.05	1.241	.1786
68	Hexafluoroethane C ₂ F ₆ (Freon-116)	.2421	.1834	6.157
69	Hexane C ₆ H ₁₄	.1792	.3968	3.845

INDEX	ACTUAL GAS	K Factor Relative to N ₂	Cp [Cal/g]	DENSITY [g/l]
70	Hydrogen H ₂ -1 (<10-100 L)	1.0106	3.419	.0899
	Hydrogen H ₂ -2 (>10-100 L)	1.35	3.419	.0899
	Hydrogen H ₂ -3 (>100 L)	1.9	3.419	.0899
71	Hydrogen Bromide HBr	1.000	.0861	3.610
72	Hydrogen Chloride HCl	1.000	.1912	1.627
73	Hydrogen Cyanide HCN	.764	.3171	1.206
74	Hydrogen Fluoride HF	.9998	.3479	.893
75	Hydrogen Iodide HI	.9987	.0545	5.707
76	Hydrogen Selenide H ₂ Se	.7893	.1025	3.613
77	Hydrogen Sulfide H ₂ S	.80	.2397	1.520
78	Iodine Pentafluoride IF ₅	.2492	.1108	9.90
79	Isobutane CH(CH ₃) ₃	.27	.3872	3.593
80	Isobutylene C ₄ H ₆	.2951	.3701	2.503
81	Krypton Kr	1.453	.0593	3.739
82	Methane CH ₄ (<=10 L/min)	.7175	.5328	.715
	Methane CH ₄ -1 (>=10 L/min)	.75	.5328	.715
83	Methanol CH ₃	.5843	.3274	1.429
84	Methyl Acetylene C ₃ H ₄	.4313	.3547	1.787
85	Methyl Bromide CH ₃ Br	.5835	.1106	4.236
86	Methyl Chloride CH ₃ Cl	.6299	.1926	2.253
87	Methyl Fluoride CH ₃ F	.68	.3221	1.518
88	Methyl Mercaptan CH ₃ SH	.5180	.2459	2.146
89	Methyl Trichlorosilane (CH ₃)SiCl ₃	.2499	.164	6.669
90	Molybdenum Hexafluoride MoF ₆	.2126	.1373	9.366
91	Monoethylamine C ₂ H ₅ NH ₂	.3512	.387	2.011
92	Monomethylamine CH ₃ NH ₂	.51	.4343	1.386
93	Neon NE	1.46	.246	.900
94	Nitric Oxide NO	.990	.2328	1.339
95	Nitrogen N ₂	1.000	.2485	1.25
96	Nitrogen Dioxide NO ₂	.737	.1933	2.052
97	Nitrogen Trifluoride NF ₃	.4802	.1797	3.168
98	Nitrosyl Chloride NOCl	.6134	.1632	2.920
99	Nitrous Oxide N ₂ O	.7128	.2088	1.964
100	Octafluorocyclobutane (Freon-C318) C ₄ F ₈	.176	.185	8.397
101	Oxygen O ₂	.9926	.2193	1.427

INDEX	ACTUAL GAS	K Factor Relative to N ₂	Cp [Cal/g]	DENSITY [g/l]
102	Oxygen Difluoride OF ₂	.6337	.1917	2.406
103	Ozone	.446	.195	2.144
104	Pentaborane B ₅ H ₉	.2554	.38	2.816
105	Pentane C ₅ H ₁₂	.2134	.398	3.219
106	Perchloryl Fluoride ClO ₃ F	.3950	.1514	4.571
107	Perfluoropropane C ₃ F ₈	.174	.197	8.388
108	Phosgene COCl ₂	.4438	.1394	4.418
109	Phosphine PH ₃	.759	.2374	1.517
110	Phosphorous Oxychloride POCl ₃	.36	.1324	6.843
111	Phosphorous Pentafluoride PH ₅	.3021	.1610	5.620
112	Phosphorous Trichloride PCl ₃	.30	.1250	6.127
113	Propane C ₃ H ₈	.35	.399	1.967
114	Propylene C ₃ H ₆	.40	.366	1.877
115	Silane SiH ₄	.5982	.3189	1.433
116	Silicon Tetrachloride SiCl ₄	.284	.1270	7.580
117	Silicon Tetrafluoride SiF ₄	.3482	.1691	4.643
118	Sulfur Dioxide SO ₂	.69	.1488	2.858
119	Sulfur Hexafluoride SF ₆	.2635	.1592	6.516
120	Sulfuryl Fluoride SO ₂ F ₂	.3883	.1543	4.562
121	Tetrafluoroethane (Forane 134A) CF ₃ CH ₂ F	.5096	.127	4.224
122	Tetrafluorohydrazine N ₂ F ₄	.3237	.182	4.64
123	Trichlorofluoromethane (Freon-11) CCl ₃ F	.3287	.1357	6.129
124	Trichlorosilane SiHCl ₃	.3278	.1380	6.043
125	1,1,2-Trichloro-1,2,2 Trifluoroethane (Freon-113) CCl ₂ FCF ₂	.2031	.161	8.36
126	Triisobutyl Aluminum (C ₄ H ₉) ₃ Al	.0608	.508	8.848
127	Titanium Tetrachloride TiCl ₄	.2691	.120	8.465
128	Trichloro Ethylene C ₂ HCl ₃	.32	.163	5.95
129	Trimethylamine (CH ₃) ₃ N	.2792	.3710	2.639
130	Tungsten Hexafluoride WF ₆	.2541	.0810	13.28
131	Vinyl Bromide CH ₂ CHBr	.4616	.1241	4.772
132	Vinyl Chloride CH ₂ CHCl	.48	.12054	2.788
133	Xenon Xe	1.44	.0378	5.858

APPENDIX IV

COMPONENT DIAGRAM DFM Analog PC Board TOP

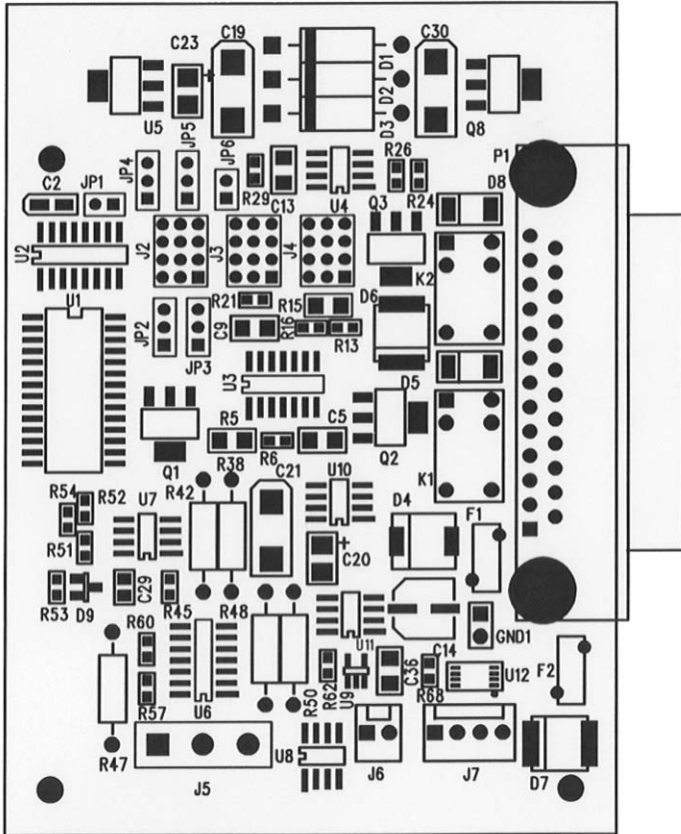

COMPONENT DIAGRAM
DFM Analog PC Board BOTTOM

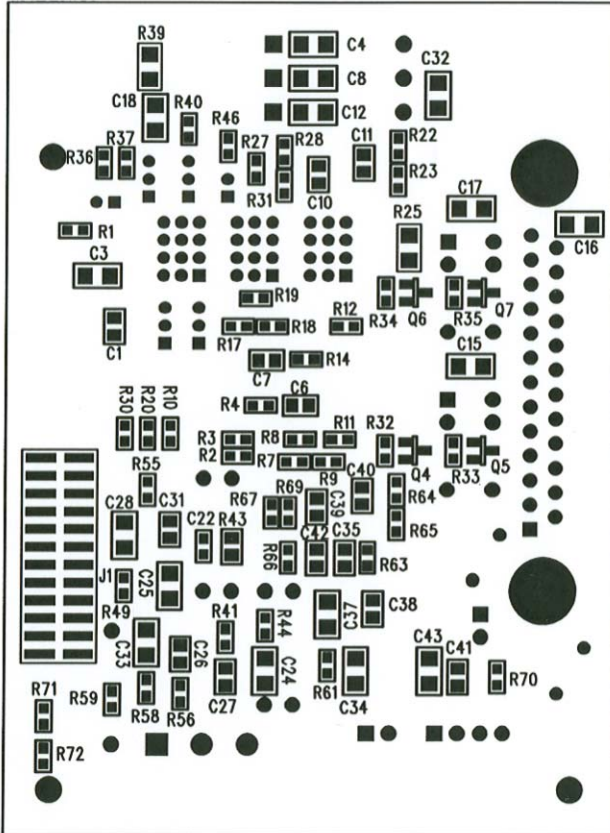

COMPONENT DIAGRAM
DFM Digital PC Board TOP

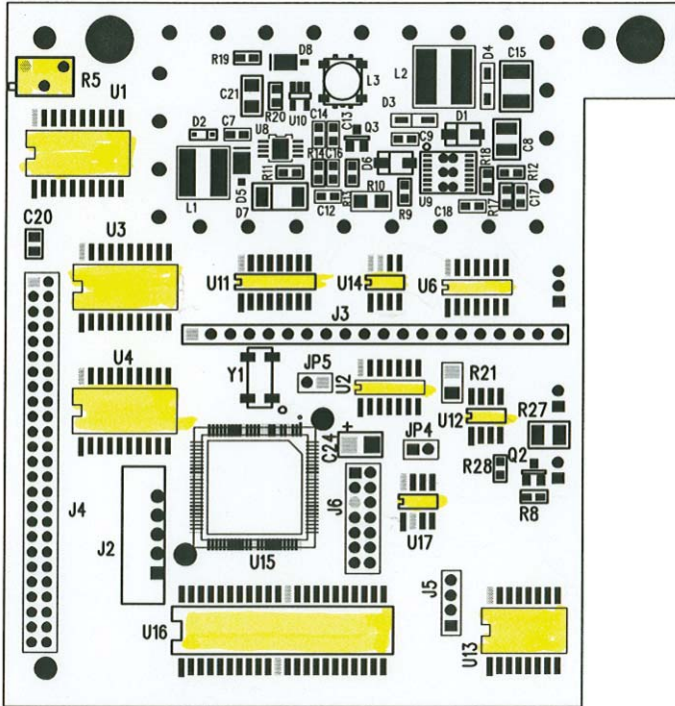

COMPONENT DIAGRAM
DFM Digital PC Board BOTTOM

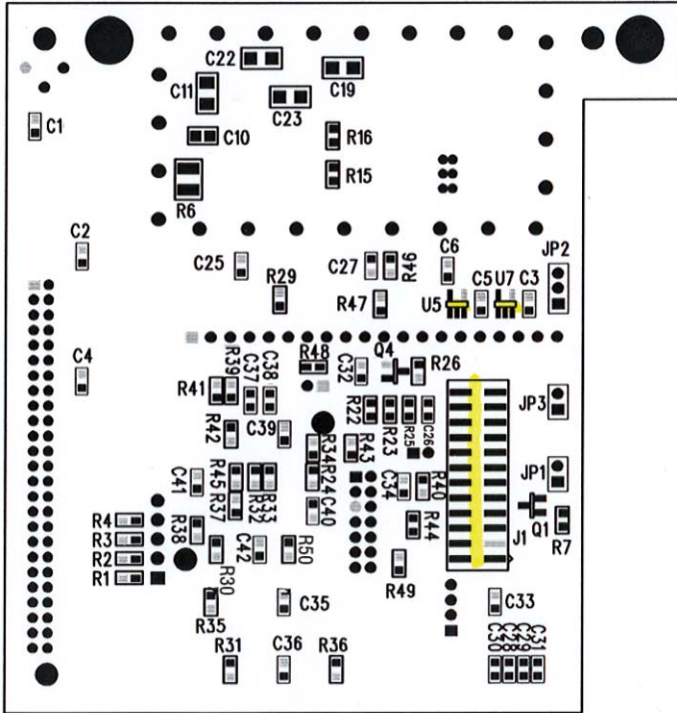

APPENDIX V

DIMENSIONAL DRAWINGS

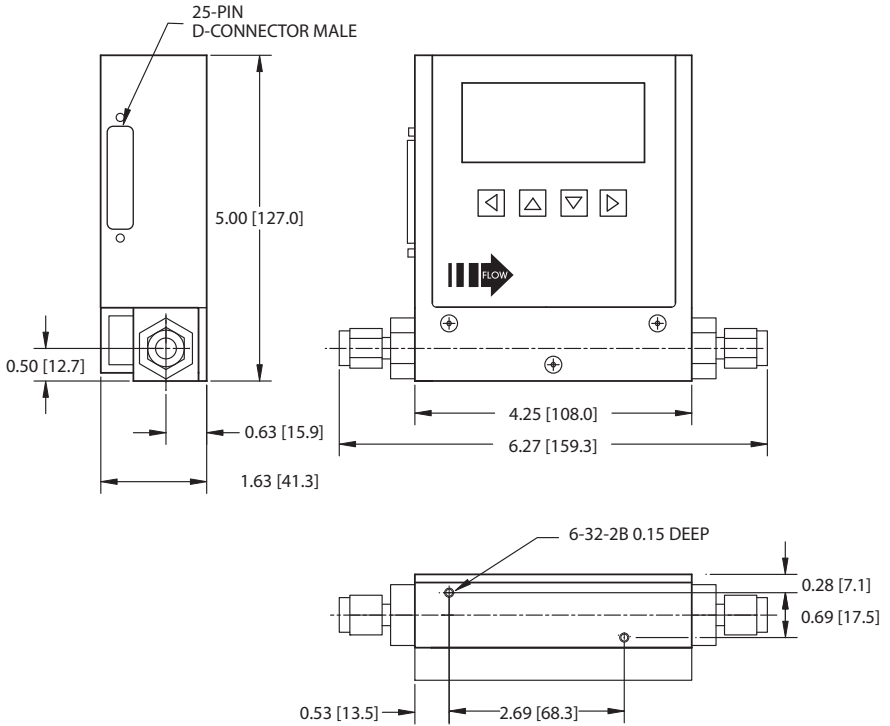

DIMENSIONAL DRAWINGS

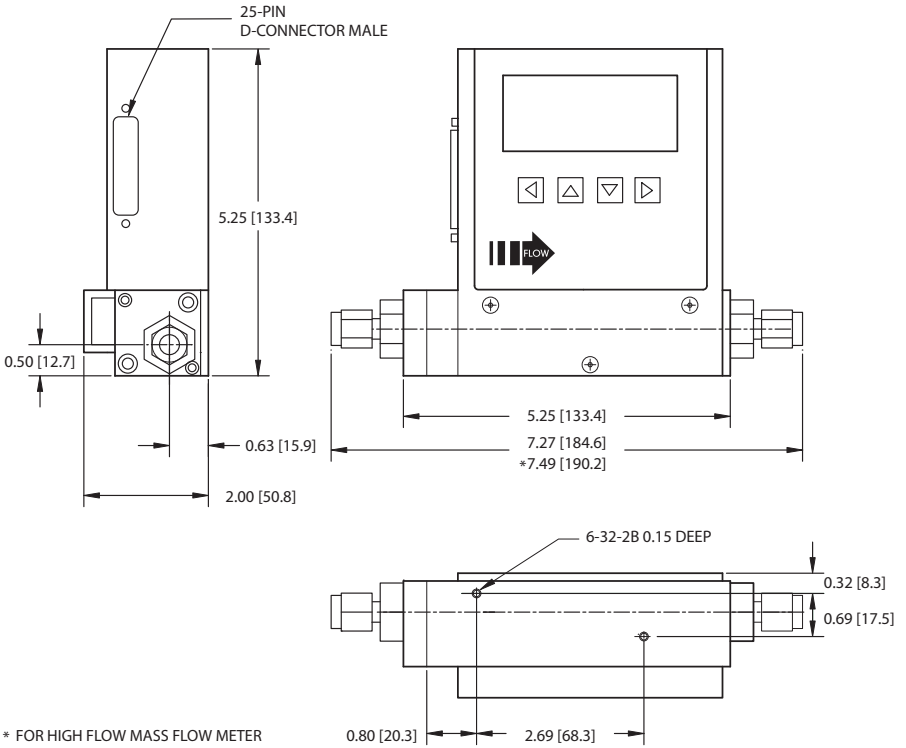

APPENDIX VI

WARRANTY

Aalborg® Mass Flow Systems are warranted against parts and workmanship for a period of one year from the date of purchase. Calibrations are warranted for up to six months after date of purchase, provided calibration seals have not been tampered with. It is assumed that equipment selected by the customer is constructed of materials compatible with gases used. Proper selection is the responsibility of the customer. It is understood that gases under pressure present inherent hazards to the user and to equipment, and it is deemed the responsibility of the customer that only operators with basic knowledge of the equipment and its limitations are permitted to control and operate the equipment covered by this warranty. Anything to the contrary will automatically void the liability of Aalborg® and the provisions of this warranty. Defective products will be repaired or replaced solely at the discretion of Aalborg® at no charge. Shipping charges are borne by the customer. This warranty is void if the equipment is damaged by accident or misuse, or has been repaired or modified by anyone other than Aalborg® or factory authorized service facility. This warranty defines the obligation of Aalborg® and no other warranties expressed or implied are recognized.

CAUTION:

This product is not intended to be used in life support applications!